

The **Making Mission Possible** Series

# Making the Hydrogen Economy Possible:

**Accelerating Clean Hydrogen in an Electrified Economy**

April 2021

Version 1.0



Energy  
Transitions  
Commission

# Making Clean Electrification Possible

## Accelerating Clean Hydrogen in an Electrified Economy

The Energy Transitions Commission (ETC) is a global coalition of leaders from across the energy landscape committed to achieving net-zero emissions by mid-century, in line with the Paris climate objective of limiting global warming to well below 2°C and ideally to 1.5°C.

Our Commissioners come from a range of organisations – energy producers, energy-intensive industries, technology providers, finance players and environmental NGOs – which operate across developed and developing countries and play different roles in the energy transition. This diversity of viewpoints informs our work: our analyses are developed with a systems perspective through extensive exchanges with experts and practitioners. The ETC is chaired by Lord Adair Turner who works with the ETC team, led by Faustine Delasalle. Our Commissioners are listed on the next page.

**Making Clean Electrification Possible: 30 Years to Electrify the Global Economy and Making the Hydrogen Economy Possible: Accelerating Clean Hydrogen in an Electrified Economy** were developed by the Commissioners with the support of the ETC Secretariat, provided by SYSTEMIQ. They bring together and build on past ETC publications, developed in close consultation with hundreds of experts from companies, industry initiatives, international organisations, non-governmental organisations and academia.

The reports draw upon analyses carried out by ETC knowledge partners SYSTEMIQ and BloombergNEF, alongside analyses developed by Climate Policy Initiative, Material Economics, McKinsey & Company, Rocky Mountain Institute, The Energy and Resources Institute, and Vivid Economics for and in partnership with the ETC in the past. We also reference analyses from the International Energy Agency and IRENA. We warmly thank our knowledge partners and contributors for their inputs.

This report constitutes a collective view of the Energy Transitions Commission. Members of the ETC endorse the general thrust of the arguments made in this report but should not be taken as agreeing with every finding or recommendation. The institutions with which the Commissioners are affiliated have not been asked to formally endorse the report.

The ETC Commissioners not only agree on the importance of reaching net-zero carbon emissions from the energy and industrial systems by mid-century, but also share a broad vision of how the transition can be achieved. The fact that this agreement is possible between leaders from companies and organisations with different perspectives on and interests in the energy system should give decisionmakers across the world confidence that it is possible simultaneously to grow the global economy and to limit global warming to well below 2°C, and that many of the key actions to achieve these goals are clear and can be pursued without delay.

**Learn more at:**

[www.energy-transitions.org](http://www.energy-transitions.org)

[www.linkedin.com/company/energy-transitionscommission](https://www.linkedin.com/company/energy-transitionscommission)

[www.twitter.com/ETC\\_energy](https://www.twitter.com/ETC_energy)

# Our Commissioners

**Mr. Marco Alvera,**  
Chief Executive Officer – SNAM

**Mr. Thomas Thune Anderson,**  
Chairman of the Board – Ørsted

**Mr. Manish Bapna,**  
Interim CEO & President - WRI

**Mr. Spencer Dale,**  
Group Chief Economist – BP

**Mr. Bradley Davey,**  
Chief Commercial Officer  
– ArcelorMittal

**Mr. Pierre-André de Chalendar,**  
Chairman and Chief Executive Officer  
– Saint Gobain

**Dr. Vibha Dhawan,**  
Director-General, The Energy and  
Resources Institute

**Mr. Agustin Delgado,**  
Chief Innovation and Sustainability  
Officer – Iberdrola

**Ms. Marisa Drew,**  
Chief Sustainability Officer & Global  
Head Sustainability Strategy, Advisory  
and Finance – Credit Suisse

**Mr. Will Gardiner,**  
Chief Executive Officer – DRAX

**Mr. John Holland-Kaye,**  
Chief Executive Officer  
– Heathrow Airport

**Mr. Chad Holliday,**  
Chairman – Royal Dutch Shell

**Mr. Fred Hu,**  
Founder and Chairman  
– Primavera Capital

**Dr. Timothy Jarratt,**  
Chief of Staff - National Grid

**Mr. Hubert Keller,**  
Managing Partner – Lombard Odier

**Ms. Zoe Knight,**  
Managing Director and Group Head  
of the HSBC Centre of Sustainable  
Finance – HSBC

**Mr. Jules Kortenhorst,**  
Chief Executive Officer  
– Rocky Mountain Institute

**Mr. Mark Laabs,**  
Managing Director – Modern Energy

**Mr. Richard Lancaster,**  
Chief Executive Officer – CLP

**Mr. Colin Le Duc,**  
Founding Partner – Generation IM

**Mr. Li Zheng,**  
Executive Vice President – Institute  
of Climate Change and Sustainable  
Development, Tsinghua University

**Mr. Li Zhengu,**  
President – LONGi Solar

**Mr. Martin Lindqvist,**  
Chief Executive Officer and President  
– SSAB

**Mr. Auke Lont,**  
Chief Executive Officer and President  
– Statnett

**Mr. Johan Lundén,**  
SVP Head of Project and Product  
Strategy Office – Volvo Group

**Dr. María Mendiluce,**  
Chief Executive Officer – We Mean  
Business

**Mr. Jon Moore,**  
Chief Executive Officer –  
BloombergNEF

**Mr. Julian Mylchreest,**  
Managing Director, Global Co-Head of  
Natural Resources (Energy, Power &  
Mining) – Bank of America

**Ms. Damilola Ogunbiyi,**  
Chief Executive Officer  
– Sustainable Energy For All

**Mr. Paddy Padmanathan,**  
President and CEO – ACWA Power

**Mr. Vinayak Pai,**  
Group President EMEA & APAC  
– Worley

**Ms. Nandita Parshad,**  
Managing Director,  
Sustainable Infrastructure Group  
– EBRD

**Mr. Sanjiv Paul,**  
Vice President Safety Health and  
Sustainability – Tata Steel

**Mr. Alistair Phillips-Davies,**  
CEO – SSE

**Mr. Andreas Regnell,**  
Senior Vice President Strategic  
Development – Vattenfall

**Mr. Siddharth Sharma,**  
Group Chief Sustainability Officer  
– Tata Sons Private Limited

**Mr. Mahendra Singhi,**  
Managing Director and CEO – Dalmia  
Cement (Bharat) Limited

**Mr. Sumant Sinha,**  
Chairman and Managing Director  
– Renew Power

**Mr. Ian Simm,**  
Founder and Chief Executive Officer  
– Impax

**Lord Nicholas Stern,**  
IG Patel Professor of Economics and  
Government - Grantham Institute  
- LSE

**Dr. Günther Thallinger,**  
Member of the Board of Management  
– Allianz

**Mr. Simon Thompson,**  
Chairman – Rio Tinto

**Dr. Robert Trezona,**  
Head of Cleantech – IP Group

**Mr. Jean-Pascal Tricoire,**  
Chairman and Chief Executive Officer  
– Schneider Electric

**Ms. Laurence Tubiana,**  
Chief Executive Officer - European  
Climate Foundation

**Lord Adair Turner,**  
Co-Chair – Energy Transitions  
Commission

**Senator Timothy E. Wirth,**  
President Emeritus – United Nations  
Foundation

**Mr. Zhang Lei,**  
Chief Executive Officer  
– Envision Group

**Dr. Zhao Changwen,**  
Director General Industrial Economy  
– Development Research Center of  
the State Council

**Ms. Cathy Zoi,**  
President – EVgo

# Contents

---

The Energy Transitions Commission	2
Our Commissioners	3
Glossary	6
Introduction	10

---

<b>Chapter 1</b>	<b>12</b>
<b>A vision for 2050: Hydrogen's role in a zero-carbon, deeply electrified economy</b>	
I. Potential demand growth	14
Hydrogen's advantages and disadvantages	16
Hydrogen's advantages and disadvantages	17
An illustrative scenario for hydrogen use by mid-century	22
II. Falling production costs and implications for the cost of decarbonisation	23
Options for zero-carbon hydrogen production	20
Potential for cost reductions: very large for green, more limited for blue	23
The long-term balance – green dominates except where gas prices are very low	26
The green cost premium in end use application – large at product level, but small for consumers	28
III. Transport, storage and international trade of hydrogen	36
Hydrogen transport options and costs	33
Alternatives to hydrogen transport	34
Storage options and costs	37
All-in costs, including conversion, transport and storage	44
International trade in 2050 – opportunities and choices: hydrogen, natural gas or electrons	45

---

---

## **Chapter 2** **48**

### **Scale-up challenges, required actions and investments**

I.	Critical scale and pace of cost declines	50
	Electrolyser costs	50
	Electricity prices – in part a function of electrolyser costs	54
II.	Feasible paths to 2050 – the need to accelerate demand growth	58
	Credible scale-up pathways to 2050 targets	58
	Driving early demand	59
III.	Key actions to enable production ramp-up	59
	Green hydrogen production growth	59
	Blue hydrogen ramp-up	62
	Illustrative scenario for green versus blue hydrogen	63
IV.	Developing transportation and storage infrastructure	66
	Hydrogen cluster archetypes	66
	Factors determining optimal cluster development	69
V.	Developing transportation and storage infrastructure	70
VI.	Safety, quality and low-carbon standards	71
VII.	Total investment needs	72

---

## **Chapter 3** **74**

### **Critical policy and industry actions in the 2020s**

I.	Critical targets for 2025 and 2030	76
II.	Carbon pricing – an essential and powerful lever	77
III.	Demand-side support – compensating the green premium sector by sector	77
IV.	Supply-side support – national targets and investment support for electrolyser capacity growth	80
V.	R&D and deployment support for new technologies	80
VI.	Hydrogen clusters development	83
VII.	Standards and Certifications	85
VIII.	Summary of critical actions for policymakers, industry, finance, innovators and consumers	87

---

Concluding remarks	89
Acknowledgements	90

---

# Glossary

**Abatement cost:** The cost of reducing CO<sub>2</sub> emissions, usually expressed in US\$ per tonne of CO<sub>2</sub>.

**BECCS:** A technology that combines bioenergy with carbon capture and storage to produce net negative greenhouse gas emissions.

**BEV:** Battery-electric vehicle.

**Biomass or bio-feedstock:** Organic matter, i.e. biological material, available on a renewable basis. Includes feedstock derived from animals or plants, such as wood and agricultural crops, organic waste from municipal and industrial sources, or algae.

**Bioenergy:** Renewable energy derived from biological sources, in the form of solid biomass, biogas or biofuels.

**Carbon capture and storage or use (CCS/U):** We use the term “carbon capture” to refer to the process of capturing CO<sub>2</sub> on the back of energy and industrial processes. Unless specified otherwise, we do not include direct air capture (DAC) when using this term. The term “carbon capture and storage” refers to the combination of carbon capture with underground carbon storage; while “carbon capture and use” refers to the use of carbon in carbon-based products in which CO<sub>2</sub> is sequestered over the long term (eg, in concrete, aggregates, carbon fibre). Carbon-based products that only delay emissions in the short term (eg, synfuels) are excluded when using this terminology.

**Carbon emissions / CO<sub>2</sub> emissions:** We use these terms interchangeably to describe anthropogenic emissions of carbon dioxide in the atmosphere.

**Carbon offsets:** Reductions in emissions of carbon dioxide (CO<sub>2</sub>) or greenhouse gases made by a company, sector or economy to compensate for emissions made elsewhere in the economy.

**Carbon price:** A government-imposed pricing mechanism, the two main types being either a tax on products and services based on their carbon intensity, or a quota system setting a cap on permissible emissions in the country or region and allowing companies to trade the right to emit carbon (i.e. as allowances). This should be distinguished from some companies’ use of what are sometimes called “internal” or “shadow” carbon prices, which are not prices or levies, but individual project screening values.

**Circular economy models:** Economic models that ensure the recirculation of resources and materials in the economy, by recycling a larger share of materials, reducing waste in production, light-weighting products and structures, extending the lifetimes of products, and deploying new business models based around sharing of cars, buildings, and more.

**Combined cycle gas turbine (CCGT):** An assembly of heat engines that work in tandem from the same source of heat to convert it into mechanical energy driving electric generators.

**Decarbonisation solutions:** We use the term “decarbonisation solutions” to describe technologies or business models that reduce anthropogenic carbon emissions by unit of product or service delivered through energy productivity improvement, fuel/feedstock switch, process change or carbon capture. This does not necessarily entail a complete elimination of CO<sub>2</sub> use, since (i) fossil fuels might still be used combined with CCS/U, (ii) the use of biomass or synthetic fuels can result in the release of CO<sub>2</sub>, which would have

been previously sequestered from the atmosphere through biomass growth or direct air capture, and (iii) CO<sub>2</sub> might still be embedded in the materials (eg, in plastics).

**Direct air capture (DAC):** The extraction of carbon dioxide from atmospheric air.

**Electrolysis:** A technique that uses electric current to drive an otherwise non-spontaneous chemical reaction. One form of electrolysis is the process that decomposes water into hydrogen and oxygen, taking place in an electrolyser and producing “green hydrogen”. It can be zero-carbon if the electricity used is zero-carbon.

**Embedded carbon emissions:** Lifecycle carbon emissions from a product, including carbon emissions from the materials input production and manufacturing process.

**Emissions from the energy and industrial system:** All emissions arising either from the use of energy or from chemical reactions in industrial processes across the energy, industry, transport and buildings sectors. It excludes emissions from the agriculture sector and from land use changes.

**Emissions from land use: All** emissions arising from land use change, in particular deforestation, and from the management of forest, cropland and grazing land. The global land use system is currently emitting CO<sub>2</sub> as well as other greenhouse gases, but may in the future absorb more CO<sub>2</sub> than it emits.

**Energy productivity:** Energy use per unit of GDP.

**Final energy consumption:** All energy supplied to the final consumer for all energy uses.

---

**Fuel cell electric vehicle (FCEV):**

Electric vehicle using a fuel cell generating electricity to power the motor, generally using oxygen from the air and compressed hydrogen.

**Greenhouse gases (GHGs):** Gases that trap heat in the atmosphere – CO<sub>2</sub> (76%), methane (16%), nitrous oxide (6%) and fluorinated gases (2%).

**Hydrocarbons:** An organic chemical compound composed exclusively of hydrogen and carbon atoms. Hydrocarbons are naturally occurring compounds and form the basis of crude oil, natural gas, coal and other important energy sources.

**Internal combustion engine (ICE):**

A traditional engine, powered by gasoline, diesel, biofuels or natural gas. It is also possible to burn ammonia or hydrogen in an ICE.

**Levelised cost of electricity (LCOE):**

A measure of the average net present cost of electricity generation for a generating plant over its lifetime. The LCOE is calculated as the ratio between all the discounted costs over the lifetime of an electricity-generating plant divided by a discounted sum of the actual energy amounts delivered.

**Natural carbon sinks:** Natural reservoirs storing more CO<sub>2</sub> than they emit. Forests, plants, soils and oceans are natural carbon sinks.

**Nature-based solutions:** Actions to protect, sustainably manage and restore natural or modified ecosystems which constitute natural carbon sinks, while simultaneously providing human, societal and biodiversity benefits.

**Near-total-variable-renewable**

**power system:** We use this term to refer to a power system where 85-90% of power supply is provided by variable renewable energies (solar and wind), while 10-15% is provided by dispatchable/peaking capacity, which can be hydro, biomass plants or fossil fuels plants (combined with carbon capture to reach a zero-carbon power system).

**Net-zero-carbon-emissions / Net-zero-carbon / Net-zero:**

We use these terms interchangeably to describe the situation in which the energy and industrial system as a whole or a specific economic sector releases no CO<sub>2</sub> emissions – either because it doesn't produce any or because it captures the CO<sub>2</sub> it produces to use or store. In this situation, the use of offsets from other sectors ("real net-zero") should be extremely limited and used only to compensate for residual emissions from imperfect levels of carbon capture, unavoidable end-of-life emissions, or remaining emissions from the agriculture sector.

**Primary energy consumption:**

Crude energy directly used at the source or supplied to users without transformation – that is, energy that has not been subjected to a conversion or transformation process.

**Steam methane reforming (SMR):**

A process in which methane from natural gas is heated and reacts with steam to produce hydrogen.

**SMR with carbon capture and**

**storage (SMR+CCS):** Hydrogen production from SMR, where the carbon emitted from the combustion of natural gas is captured to be stored or used.

**Sustainable biomass / bio-feedstock**

**/ bioenergy:** In this report, the term 'sustainable biomass' is used to describe biomass that is produced without triggering any destructive land use change (in particular deforestation), is grown and harvested in a way that is mindful of ecological considerations (such as biodiversity and soil health), and has a lifecycle carbon footprint at least 50% lower than the fossil fuels alternative (considering the opportunity cost of the land, as well as the timing of carbon sequestration and carbon release specific to each form of bio-feedstock and use).

**Synfuels:** Hydrocarbon liquid fuels produced synthesising hydrogen from water, carbon dioxide and electricity. They can be zero-carbon if the electricity input is zero-carbon and the CO<sub>2</sub> from direct air capture. Also known as "synthetic fuels", "power-to-fuels" or "electro-fuels".

**Zero-carbon energy sources:**

Term used to refer to renewables (including solar, wind, hydro, geothermal energy), sustainable biomass, nuclear and fossil fuels if and when their use can be decarbonised through carbon capture.





# Major ETC reports and working papers



## Global reports



**Better Energy, Greater Prosperity** (2017) outlined four complementary decarbonisation strategies, positioning power decarbonisation and clean electrification as major complementary progress levers.



**Mission Possible** (2018) outlined pathways to reach net-zero emissions from the harder-to-abate sectors in heavy industry (cement, steel, plastics) and heavy-duty transport (trucking, shipping, aviation).



**Making Mission Possible** (2020) showed that a net-zero global economy is technically and economically possible by mid-century and will require a profound transformation of the global energy system.



## Sectoral and cross-sectoral focuses



Sectoral focuses provided detailed decarbonisation analyses on each of the six harder-to-abate sectors after the publication of the Mission Possible report (2019). Our latest focus on building heating (2020) details decarbonisation pathways and costs for building heating, and implications for energy systems (include cover of Mission Possible cement report).

As a core partner of the Mission Possible Partnership, the ETC also completes analysis to support a range of sectoral decarbonisation initiatives:



In October 2020, the corporate members of the Clean Skies for Tomorrow initiative (CST) developed a **Joint Policy Proposal to Accelerate the Deployment of Sustainable Aviation Fuels in Europe**

Produced for the Getting to Zero Coalition, **"The First Wave – A blueprint for commercial-scale zero-emission shipping pilots"** highlights five key actions that first movers can take to make tangible progress towards zero emission pilots over the next three to four years (include front cover of the report).



## Geographical focuses



**China 2050: A Fully Developed Rich Zero-carbon Economy** described the possible evolution of China's energy demand sector by sector, analysing energy sources, technologies and policy interventions required to reach net-zero carbon emissions by 2050.



**China Zero Carbon Electricity Growth in the 2020s: A Vital Step Toward Carbon Neutrality** (January 2021). Following the announcement of China's aim to achieve carbon neutrality before 2060 and peak emissions before 2030. This report examines what action is required by 2030 aligned with what is needed to fully decarbonise China's power sector by 2050.



**A series of reports on the Indian power system and outlining decarbonisation roadmaps for Indian industry (2019-2020)** described how India could rapidly expand electricity supply without building more coal-fired power stations, and how India can industrialise whilst decarbonising heavy industry sectors.

# Introduction

Clean electrification must be at the heart of all strategies to achieve a zero-carbon economy, with electricity applied to a far wider range of end applications than today and all electricity produced in a zero-carbon fashion. Electrification is indeed the most efficient way to meet most energy needs. Thanks to both decreasing all-in generation cost and the inherent efficiency gain associated with a switch to electricity, clean electrification can lower total energy system costs, while also delivering major local environmental benefits. As the ETC's latest report on the global power system describes, direct electricity use could and should grow from today's 20% of total final energy demand to reach close to 70% by 2050, with electricity generation to support direct electrification growing from 27,000 TWh to around 90,000 TWh.<sup>1</sup>

However, in some sectors, direct electrification will likely remain impossible or uneconomic for many decades. In many of these, hydrogen can play a major role in decarbonisation whether used directly or in the form of derived fuels such as ammonia and synthetic fuels (synfuels). In steel and long-distance shipping, for instance, hydrogen's vital new role is increasingly certain; in fertiliser production, it will continue to be essential; and in multiple other sectors, it is among the leading decarbonisation options. Hydrogen will also almost certainly play a major energy storage role in future electricity systems, helping to balance supply and demand in systems where most electricity is supplied from variable renewable sources.

Total global hydrogen use could therefore grow 5-7-fold from today's 115 Mt per annum to reach 500 to 800 Mt by mid-century,<sup>2</sup> with hydrogen (and its derivatives) accounting for 15-20%<sup>3</sup> of final energy demand, on top of the close to 70% provided by direct electricity.

All of this hydrogen must be produced in a zero-carbon fashion via electrolysis using zero-carbon electricity ("green hydrogen") or in a low-carbon fashion using natural gas reforming plus CCS ("blue hydrogen") if deployed in a manner that achieves near-total CO<sub>2</sub> capture and very low methane leakage. Blue hydrogen will often be cost-effective during the transition, particularly via retrofit of existing grey hydrogen, and in the long term in locations with very low gas prices. But green hydrogen will be lower cost in most locations over the long term, with dramatic production cost reductions to below \$2/kg possible during the 2020s, and further falls thereafter. Hydrogen production will therefore be predominantly via a green route (ca. 85%) and generate very large electricity demand, increasing the total required supply of zero-carbon electricity by 30,000 TWh or more on top of the 90,000 TWh potentially needed for direct electrification.

Strategies to achieve net-zero emissions by mid-century in both developed and developing countries must therefore recognise the major role of green hydrogen and the implications for required clean electricity supply – which, although very significant, is physically and financially feasible.<sup>4</sup>

They must also ensure a sufficiently rapid take-off of hydrogen production and use during the 2020s to make it feasible to reach 2050 targets. Achieving this will require policy support because using hydrogen in end applications often imposes a green premium (versus fossil fuel technologies) even if clean hydrogen production costs fall dramatically. Those policies must combine broad policy instruments such as carbon prices, with support focused on specific sector applications and on the development of geographically-focused clusters of clean hydrogen production and use.

This report therefore sets out:

- The role of clean hydrogen in a zero-carbon deeply electrified economy;
- How to scale-up the hydrogen value chain, potential barriers, and the investments and policies required to overcome them;
- Critical industry and policy actions required during the 2020s.

1 Energy Transitions Commission (2021), *Making Clean Electrification Possible: 30 years to electrify the global economy*.

2 The lower/upper boundaries depend on the level of energy productivity improvement in the global economy.

3 The ETC scenarios illustrated in Exhibit 1.1 show 15-17% final energy demand for hydrogen and its derived fuels (ammonia, synfuels).

4 The feasible scale-up of zero-carbon power is explored in depth in the ETC's parallel report on clean electrification. Source: ETC (2021), *Making Clean Electrification Possible: 30 years to electrify the global economy*.

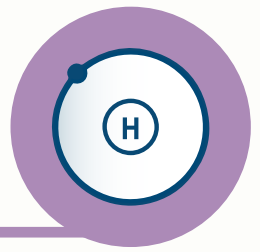

## HYDROGEN: THE SECOND DECARBONISATION VECTOR

Final energy demand, ETC 2050 Indicative Scenario

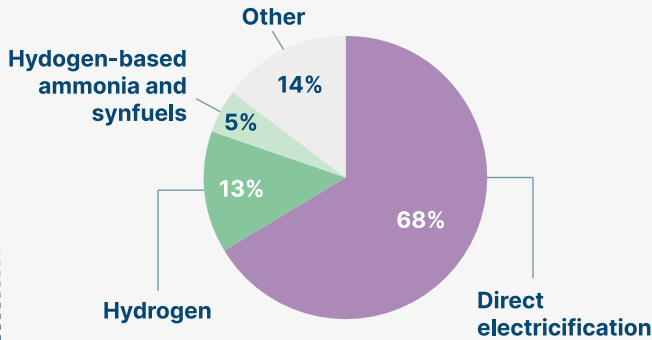

## A 5-7 FOLD INCREASE IN HYDROGEN PRODUCTION TOWARDS NET-ZERO

Hydrogen production 2050  
Mt Hydrogen / year

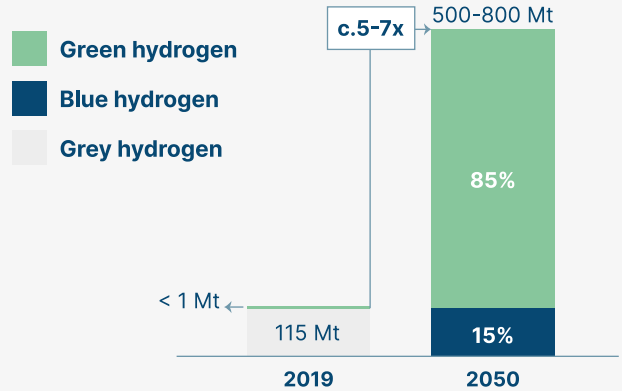

## What will it take?

SIMULTANEOUSLY

### GROW PRODUCTION VOLUMES TO MAKE GREEN HYDROGEN COMPETITIVE

Hydrogen production cost  
\$/kg

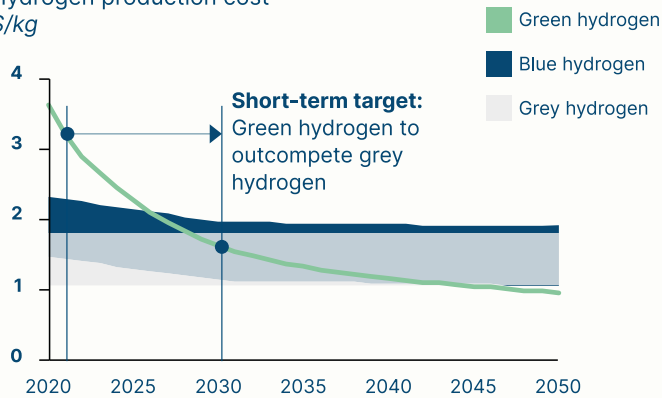

### RAPIDLY ACCELERATE DEMAND FOR CLEAN HYDROGEN

- From grey to clean**  
 Refining / Ammonia / Methanol
- Development needed but large long-term need**  
 Steel / Shipping / Aviation / Chemicals / Power
- Potential transitional**  
 Co-firing / Blending
- Possible future uses if electricity doesn't win**  
 Trucking / Residential heating / High temperature heating

### TO UNLOCK LARGE-SCALE INVESTMENT IN HYDROGEN SUPPLY

Total investment, \$ billion

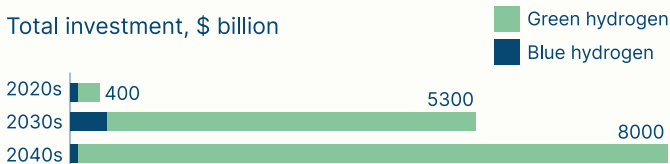

## DEVELOP TRANSPORT AND STORAGE INFRASTRUCTURE WHERE NEEDED

### Clusters

Early use cases will develop around industrial clusters with shared hydrogen production, distribution and storage infrastructure.

### Inter-regional

Limited international trade will be mainly supported by interregional pipelines and sometimes ammonia ships where final use is ammonia.



# Chapter 1

## A vision for 2050: Hydrogen's role in a zero-carbon, deeply electrified economy

Hydrogen is almost certain to play a very major role in achieving a zero-carbon economy. It can be used to decarbonise important processes in harder-to-abate transport and heavy industry sectors where direct electrification is difficult, expensive or impossible. It can also play a role as an energy storage mechanism within the power system. As the cost of producing clean hydrogen falls drastically, it will be increasingly cost-advantaged versus carbon capture and storage (CCS) or bioenergy-based routes to decarbonisation.

In the ETC’s *Making Mission Possible* report,<sup>5</sup> two illustrative mid-century net-zero pathways were described (Exhibit 1.1): (i) one considering supply-side decarbonisation plus maximum energy productivity improvements, lowering the final energy demand by 17% compared to 2019 and (ii) another relying on supply-side decarbonisation pathway only and not considering significant energy productivity improvements leading to a 15% rise in final energy demand compared to 2019. In both scenarios, hydrogen and hydrogen-based fuels represented the second largest final energy use in the economy by 2050 (15-17%), after direct use of clean electricity.

Through the transition, government policy and company strategies will be most effective if informed by a clear vision of the likely scale and nature of hydrogen opportunities over the next 30 years. This Chapter therefore sets out a vision of what the hydrogen economy<sup>6</sup> is likely to entail covering in turn:

- The potential growth of hydrogen demand;
- How fast production costs could decline and the implications for the cost of decarbonisation;
- Hydrogen transport and storage technologies and costs of this infrastructure;
- The role and long-term limitations of long-distance hydrogen transport.

## Final energy mix in a zero-carbon economy: electricity will become the dominant energy vector, complemented by hydrogen and fuels derived from it

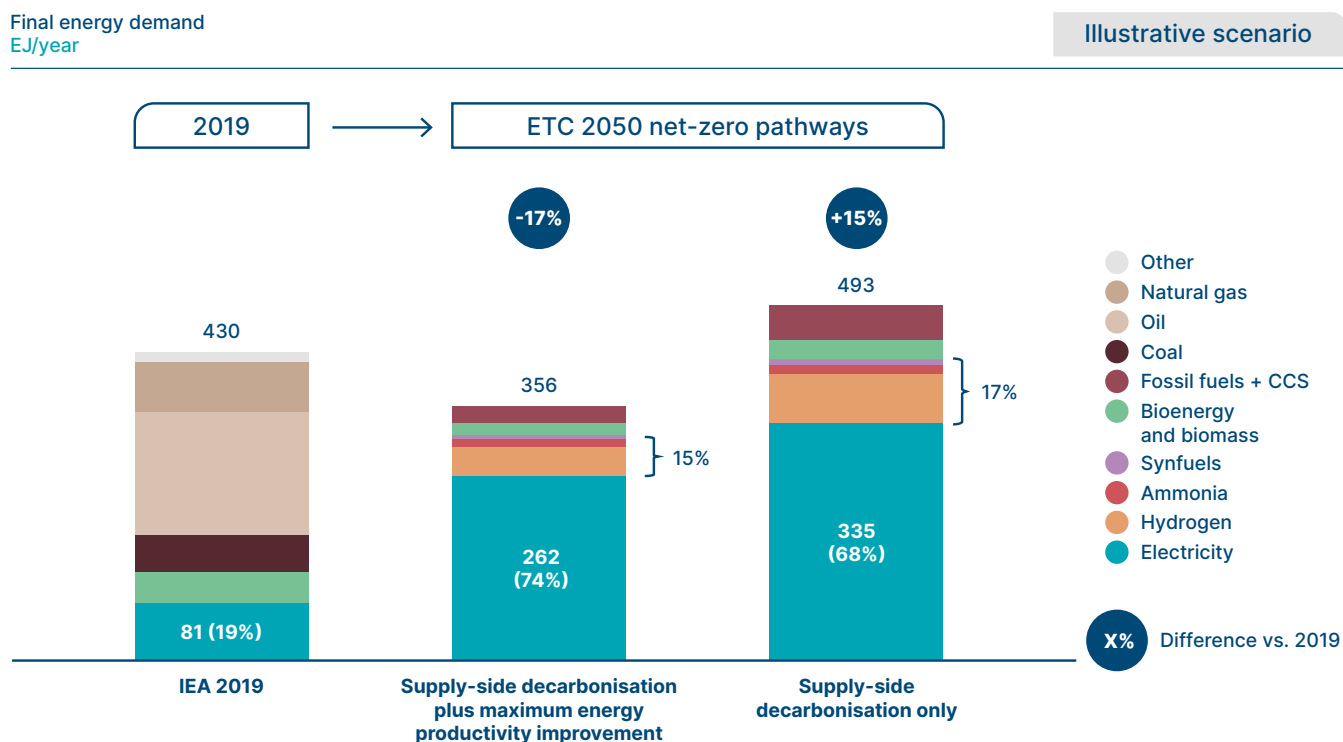

Exhibit 1.1

SOURCE: SYSTEMIQ analysis for the Energy Transitions Commission (2021); IEA (2020), *World Energy Outlook*

<sup>5</sup> ETC (2020), *Making Mission Possible*.

<sup>6</sup> The term hydrogen economy is used as a shorthand to describe a whole set of activities from production to use of clean hydrogen. However, it does not refer to clean hydrogen as an all-encompassing solution for the entire energy system as we envision hydrogen as one pillar of decarbonisation alongside mass electrification, and important but constrained complementary roles for sustainable, low-carbon bio-energy and the use of fossil fuels combined with CCS/U.

# I. Potential demand growth

In 2018, about 115 Mt of hydrogen was used globally of which 70 Mt was produced via dedicated production predominantly from natural gas (71%) and coal (27%).<sup>7</sup> This production resulted in about 830 Mt of CO<sub>2</sub> emissions, around 2.2% of the global energy-related total. The main uses of this hydrogen were in refining (38 Mt), ammonia production (31 Mt, used in particular for fertilisers production) and methanol (12 Mt, used mostly as a fuel additive and for plastics production) (Exhibit 1.2).

Over the next 30 years, hydrogen use is set to increase dramatically, with clean hydrogen replacing hydrogen derived from unabated fossil fuels in existing applications as well as being deployed in multiple new end uses. In some sectors, its precise role versus other decarbonisation options (in particular direct electrification) is inherently uncertain. However, reasonable scenarios suggest that a 2050 zero-carbon economy will need to use about 500 to 800 Mt of hydrogen per annum (see Exhibit 1.4, at the end of Section 1.1).

## Today's production of hydrogen is via carbon-intensive processes, with use of hydrogen concentrated in the refining, ammonia, and methanol sectors

Dedicated hydrogen production pathways used (2018)  
% of dedicated production

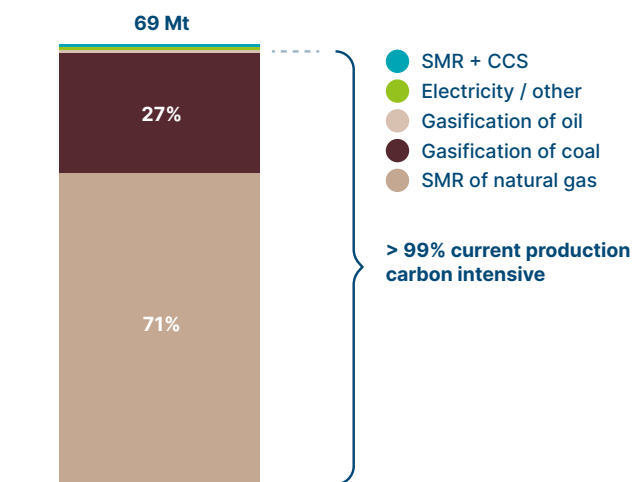

Hydrogen use sectors (2018)  
Mt H<sub>2</sub>

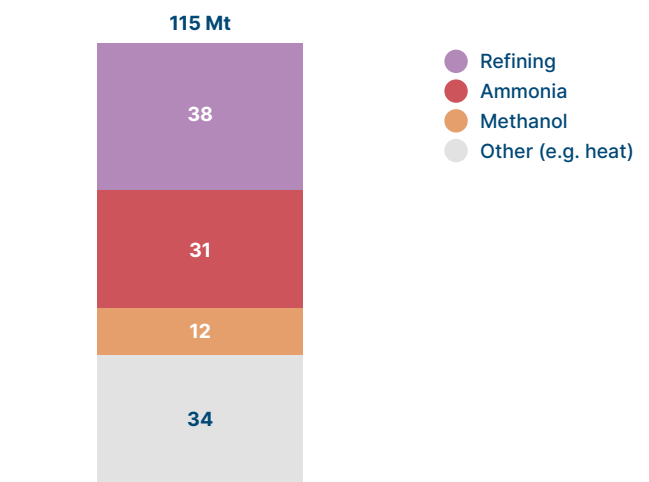

Exhibit 1.2

SOURCE: IEA (2019). *The Future of Hydrogen*

<sup>7</sup> The 45 Mt tonnes difference stems from hydrogen produced as a by-product in a number of industrial processes such as catalytic naphtha reforming, chlor-alkali electrolysis and steam cracking of propane. Source: IEA (2019), *The Future of Hydrogen*.



The role of hydrogen by sector – relative to other decarbonisation options – will reflect its inherent chemical characteristics, advantages, and disadvantages (Box A).



**As an energy source compared with direct electrification**, the use of hydrogen is generally less efficient due to energy conversion losses. Nevertheless, the higher energy density per mass of hydrogen and hydrogen-derived fuels such as ammonia or synthetic fuels, relative to batteries, will outweigh that disadvantage in long-distance transport applications. In addition, while the conversion/reconversion between electricity and hydrogen entails significant losses, hydrogen offers an economic and practical way to store large amounts of energy over the long term (weeks, months, especially to address seasonal variations).<sup>8</sup>

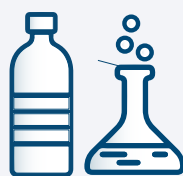

**As a chemical agent or feedstock**, hydrogen has an indispensable role in the production of ammonia and methanol, as well as a potential role in the production of plastics<sup>9</sup> and steel due to its chemical properties and reactivity.



**Safety and leakage issues**, while hydrogen is a stable non-toxic molecule which can be safely stored at room temperature and has been used in industry for many years, it poses significant storage and transport challenges due to its small molecule size, its low volumetric density (relative to methane), and its extreme flammability.<sup>10</sup> While many of the safety considerations can be overcome, these characteristics may reduce its relative attractiveness in dispersed applications (such as residential heating) which require widespread distribution. While ammonia, as hydrogen-derived fuel, does not face the same transport and storage challenge, it is toxic and requires stringent safety procedures.

<sup>8</sup> As outlined in the parallel ETC report on clean electrification, batteries are well suited to store electricity for shorter timeframes

<sup>9</sup> Plastics are produced from a wide variety of feedstock (e.g., ethylene, benzene) currently produced from oil and natural gas, that can be synthesised from methanol, itself produced from hydrogen and CO<sub>2</sub>, see page 14.

<sup>10</sup> In comparison to natural gas, hydrogen has the advantage that it disperses very quickly and does not sink to the ground, reducing the danger associated with low level leakage.



# Hydrogen as an energy source: Technical advantages & disadvantages

Hydrogen effectively extends the reach of renewables to the decarbonisation of harder-to-abate sectors. It has many advantages including producing no emissions upon combustion and a very high energy density per kg. However, its production and conversion entail energy losses, and its end-use efficiency is generally lower than direct electrification.

## Energy efficiency

Direct electrification is generally more efficient than hydrogen applications due to hydrogen production losses (ca. 20-40%<sup>1</sup>) and lower efficiency of end-use applications:

- Heat pumps offer ca. 5-6x more heat energy per energy input compared to hydrogen
- Fuel cell vehicles are lower efficiency due to Power-Hydrogen-Power reconversion losses
- Relative competitiveness for high temp. heat remains unclear, however superior energy efficiency of direct electrification likely to make hydrogen less attractive

Sector	Technology option	Energy Efficiency <sup>5</sup>
Building heating <sup>2</sup>	Hydrogen boiler	46%
	Electric heat pump	270%
Road Transport <sup>3</sup>	Fuel Cell Electric Vehicle	26%
	Battery Electric Vehicle	70%
High temp. heat <sup>4</sup>	Hydrogen tech.	55-80%
	Direct electrification tech.	50-90%

## Energy storage

Large-scale long-duration energy storage with batteries is difficult due to the high mass and volume required (see energy density box).

Hydrogen can be safely stored, without energy losses, in large quantities in geological hydrogen storage. While energy losses in power-hydrogen-power re-conversion are significant, the need for long-duration energy storage for grid balancing in renewables dominated systems means hydrogen is likely to be crucial.<sup>6</sup>

### Conversion efficiency of energy storage for power %

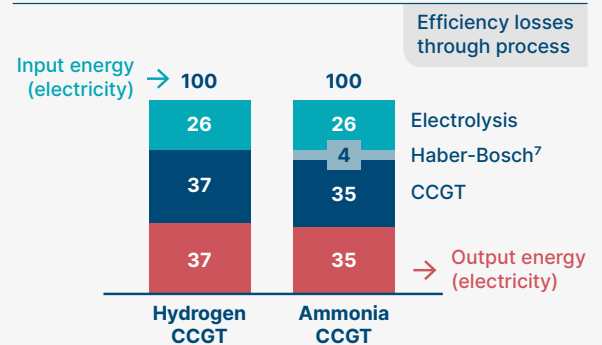

## Energy density

Hydrogen has a much higher energy density per mass<sup>8</sup> than batteries and is therefore attractive in transport applications where large amounts of energy are required at minimal weight (aviation, shipping, long distance trucking).

### Gravimetric energy density MJ/kg

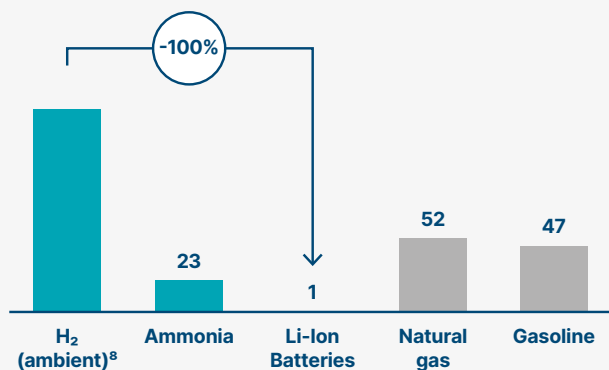

However, hydrogen's energy density per volume is very low, even in compressed or liquified form which makes ammonia and synfuels more attractive for longer distances (long distance aviation & shipping).

### Volumetric energy density MJ/m<sup>3</sup>

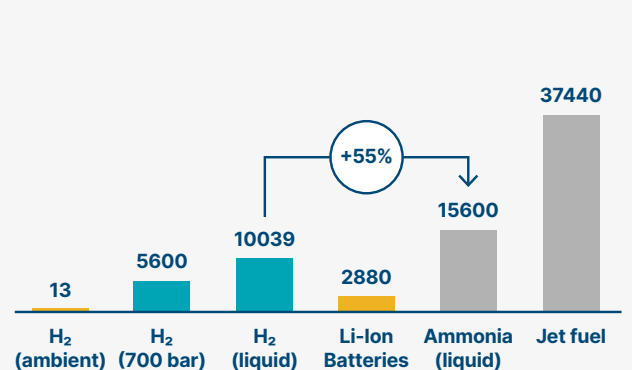

NOTES: <sup>1</sup> Approximate efficiency range for green and blue production between now and 2050; <sup>2</sup> Further considerations include: quality of grid and pipeline infrastructure, peak load demand on electricity grid; <sup>3</sup> Other considerations beyond energy efficiency include (not exhaustive): vehicle range & cost, refueling / charging infrastructure, fuel cost; <sup>4</sup> Range illustrates different technologies for both hydrogen and direct electrification of high temperature heat; <sup>5</sup> Energy efficiency describes the ratio of final output energy to input energy. It includes losses from hydrogen production, electricity & hydrogen transmission, reconversion processes and end-use. <sup>6</sup> See parallel ETC Clean Electrification Report; <sup>7</sup> Haber-Bosch process assumes use of by-product heat in adjacent processes. <sup>8</sup> Excluding weight of storage tanks;

SOURCE: SYSTEMIQ analysis for the Energy Transitions Commission (2021), see Annex for literature review used for this figure.



# Likely applications by sector

The potential uses of hydrogen in a zero-carbon economy can be usefully categorised into four groups (Exhibit 1.3):

- Existing uses of hydrogen offering clear short-term opportunities for a switch to clean hydrogen, with high certainty of long-term demand;
- Uses which will take time to develop, but where demand is certain to be large in the long-term;
- Potential short-term, but transitional opportunities;
- Possible future uses where the relative costs and advantages versus direct electrification and other decarbonisation options remain unclear.

## Multiple potential uses of hydrogen in a low carbon economy, some of which can provide early 'off-take' for clean hydrogen

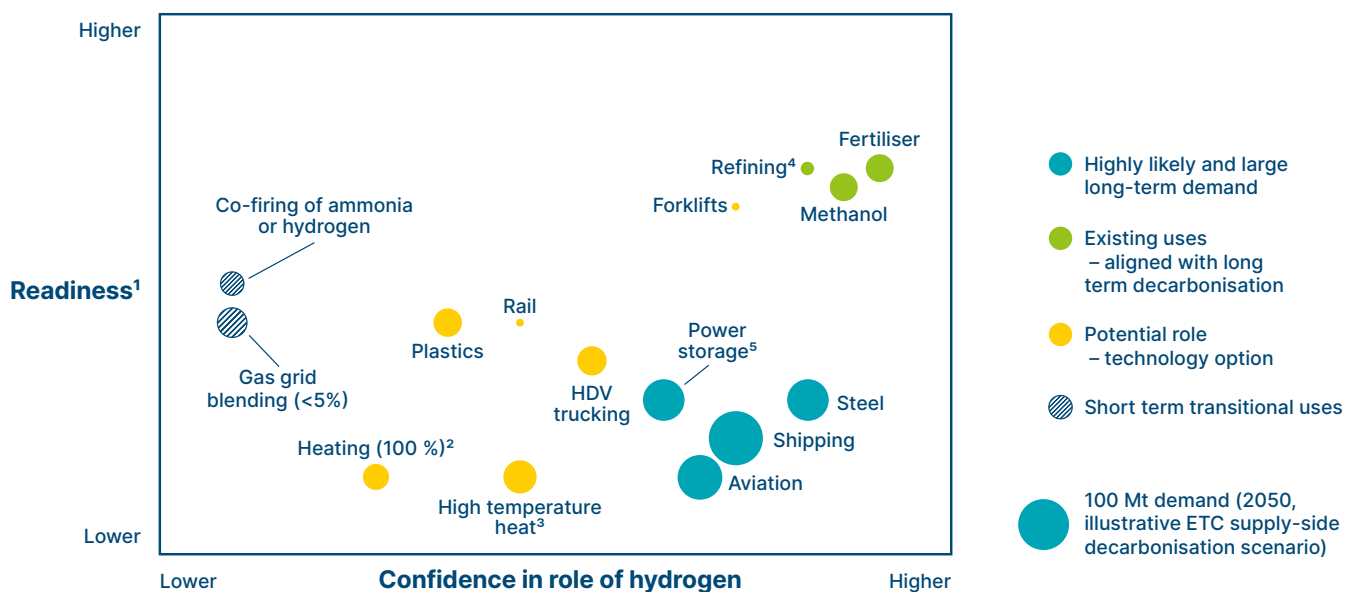

Exhibit 1.3

NOTES: <sup>1</sup> Readiness refers to a combined metric of technical readiness for clean hydrogen use, economic competitiveness and ease of sector to use clean hydrogen. <sup>2</sup> 'Heating (100%)' refers to building heating with hydrogen boilers via hydrogen distribution grid. <sup>3</sup> 'High temperature heat' refers to industrial heat processes above ca. 800°C. <sup>4</sup> Current hydrogen use in refining industry is higher due to greater oil consumption. <sup>5</sup> Long-term energy storage for the power system.

SOURCE: SYSTEMIQ analysis for the Energy Transitions Commission (2021)



**Existing uses of hydrogen** where clean hydrogen can substitute grey hydrogen production in the short term, often with minimal retrofitting, thus eliminating the 830 Mt of CO<sub>2</sub> currently being released,<sup>11</sup> include:



**Crude oil refining**, where hydrogen is used in desulphurisation and in hydrocracking to upgrade heavy residual oils. In the long term, this use will decline as demand for oil-based fuels falls, especially in the mobility sectors. Oil inputs to plastics production will also reduce through recycling and potential use of bio-feedstocks.<sup>12</sup>



**Ammonia**, where hydrogen is an essential input to the Haber-Bosch process used to produce 180 Mt of ammonia per annum, of which 80% is used for fertiliser production. Ammonia demand for existing uses is likely to continue to remain stable or grow slightly with additional demand as a result of the new applications considered below.

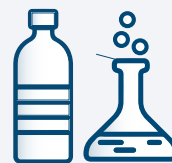

**Methanol**, of which 100 Mt per annum is currently produced from natural gas or coal-derived hydrogen, carbon dioxide and carbon monoxide. It is used in a variety of products including paints, plastics, and explosives. This demand will likely increase as plastic production shifts from oil or gas-based production processes.<sup>13</sup>

11 Typically, the hydrogen use case assets do not need to be replaced. However, the grey hydrogen production assets are generally very large and depending on their age and the ability to retrofit CCS (discussed in section 1.2) may have to be written off upon conversion to clean hydrogen.

12 Use of bio-feedstocks will likely be limited by constraints on global sustainable supply of bio-feedstocks and multiple competing demands from different sectors of the economy.

13 Production of methanol via clean hydrogen requires a CO<sub>2</sub> source which may stem from refinery emissions in the short term and transitions to sustainable CO<sub>2</sub> sources (e.g., direct air capture) in the long-term.



**Large long-term uses with significant lead times**, due to lower technological readiness, long asset lifecycles and higher abatement costs, include:



**Primary steel production**, which currently accounts for 7% (3 Gt) of global CO<sub>2</sub> emissions from the energy and industry system, and where hydrogen can replace coking coal as the reducing agent. Alternative pathways for deep decarbonisation include CCU/S and direct electrolysis of iron ore, which is currently at a pre-commercial scale technology readiness level). A number of major steel producers have set net-zero 2050 emissions targets (including Arcelor Mittal, BaoWu Steel, SSAB, and ThyssenKrupp), for which hydrogen technologies are cited as a critical technology.<sup>14</sup> In addition, several pilot projects are exploring the potential to co-feed hydrogen in existing blast furnaces to provide an incremental GHG performance improvement during the transition period (see below).



**Long-distance shipping**, where the path to decarbonisation is almost certain to involve hydrogen-based fuels – whether ammonia or methanol<sup>15</sup> – burnt in adapted versions of existing marine engines as laid out in a recent ETC report<sup>16</sup>. In addition, short distance ferries and cruise ships may use hydrogen directly as a fuel alongside direct electrification.



**Long-distance aviation**, where limits to battery energy density currently make direct electrification impossible, and where cost-effective decarbonisation is likely to entail the use of a zero-carbon equivalent of existing jet fuel. With sustainable biofuel volumes constrained (the issue of bio-feedstock availability and use will be explored in detail in the upcoming ETC report on sustainable biomass<sup>17</sup>), synthetic “power to liquid” jet fuel may be required to meet the needs of the global aviation industry.<sup>18</sup> A recent report from ATAG (the Air Transport Action Group) suggests that synthetic fuels will develop significantly over the long term, and the EU is considering a fuel mandate to drive the development of various Sustainable Aviation Fuels (SAF) routes.<sup>19</sup> In addition, as for shipping, hydrogen may be used directly at shorter distances with new aircrafts.



**Power system balancing**, where hydrogen is likely to play a significant role in providing seasonal balance and dispatchable generation within power systems dominated by variable renewables (see ETC clean electrification report for further details<sup>20</sup>). This will entail hydrogen being produced via electrolysis when power supply exceeds demand and reconverted to electricity (most likely via combustion in gas turbines<sup>21</sup>) when demand exceeds potential supply.<sup>22</sup>

14 Hydrogen-based direct reduced iron (DRI) is a different plant type that enables the use of hydrogen instead of coke in a traditional steel blast furnace. In addition, electric arc furnaces and the recycling of steel scrap will likely play an increasing role in the future.

15 Ammonia has the advantage of not requiring a sustainable CO<sub>2</sub> input for its production.

16 ETC for the Getting to Zero Coalition (2020), *The First Wave – A blueprint for commercial-scale zero-emission shipping pilots*.

17 ETC (Upcoming, 2021), *Making a Sustainable Bio-Economy Possible*.

18 Non-GHG emissions (e.g., water vapour) from synfuels will have some residual global warming effect that needs to be compensated via negative emissions.

19 The fuel mandate will likely include biofuels and synthetic aviation fuels derived from hydrogen.

20 ETC (2021), *Making Clean Electrification Possible: 30 years to electrify the global economy*.

21 Fuel Cells may offer an alternative technology to CCGTs in particular at smaller scales (e.g. 50 MW hydrogen fuel cell plant in South Korea; Source: JRC Technical Report (2019), *Global deployment of large capacity stationary fuel cells*).

22 Hydrogen can help two-fold: i) use of excess electricity on the grid and thereby help to lower power cost fluctuations in which case the hydrogen may be used in other sectors, ii) convert electricity into hydrogen at favourable times (e.g., summer in high latitudes in northern hemisphere) to store energy and reconvert to power when variable renewable energy supply is low compared to demand (e.g., winter in high latitudes in northern hemisphere).

**Potential short-term but transitional applications**, that enable partial, near-term emissions reduction of existing high-carbon assets that will eventually need to be phased out in a net-zero economy, could include:

- **Co-firing ammonia in coal power plants**, which is being trialled in Japan, but which is unlikely to prove a path to 100% ammonia power plants except in countries facing severe constraints on the supply of renewable electricity. Co-firing ammonia should not slow down efforts to retire coal generation assets.
- **Co-firing hydrogen in gas power plants**, which may be used as transitional pathway with some current power turbines able to use as much as 30% hydrogen potentially moving up to 50% with minimal capital investment for newer turbines.<sup>23</sup> Ultimately, either new turbines capable of using 100% hydrogen or CCS infrastructure will need to be installed to enable full power sector decarbonisation (see ETC clean electrification report for further details<sup>24</sup>).
- **Co-feeding hydrogen in steel blast furnaces, ammonia plants and refineries** can help to accelerate the initial development of clean hydrogen. However, only small percentages of clean hydrogen can be co-fed before larger changes on the asset are required.<sup>25</sup>
- **Blending low levels of hydrogen into an existing natural gas grid**, to generate initial demand for zero-carbon hydrogen, alongside a small reduction in the carbon intensity of methane use (see Box B). Concerns about steel pipe embrittlement for parts of the grid<sup>26</sup> and the need to retrofit or replace appliances are, however, likely to limit

## Low level blending of hydrogen into the existing natural gas grid

### A potential transitional use for clean hydrogen in the 2020s and early 2030s

Today, the natural gas grid delivers energy to industrial (e.g. power plants, high temperature heat) and residential users (space and water heating). Taking an approach to blend low levels of hydrogen into the natural gas grid requires careful consideration and can only be transitional – applicable only prior to the implementation of full decarbonisation options – e.g., direct electrification or switch to equipment which allows for 100% hydrogen use.

Key considerations for transitional use of natural gas blending include:

#### Opportunities

- **Rapid scaling of green hydrogen demand:** Potentially relatively rapid scaling of large, early hydrogen off-taker during the 2020s when clean hydrogen off-take is needed to develop the clean hydrogen economy.
- **Speed of implementation:** Small number of decision makers required to deliver significant early off-take volumes.
- **Flexible:** Hydrogen can be blended into the natural gas grid at many locations, allowing production to be sited alongside other hydrogen off-takers. Off-take can be varied, with no requirement for steady-supply.

#### Challenges

- **Carbon emissions:** Low level hydrogen blending has a small impact on reducing CO<sub>2</sub> emissions in the short term due to lower energy density of hydrogen compared to natural gas.<sup>1</sup>
- **International collaboration bottlenecks:** International coordination will sometimes be required due to cross-border natural gas grids. For example, implementation of EU wide regulation would require alignment member countries.<sup>2</sup>
- **Lock-in effect:** Risk that blending could in effect extend lifetimes of existing gas grids, preventing shifts towards full building heating decarbonisation solutions (either electrification or non-trivial switch to 100% hydrogen distribution grid, requiring conversion of all assets connected to the natural gas grid -incl. home boilers, industrial applications).
- **Potentially sub-optimal use of renewable energy:** In the 2020s, when low level gas blending feasible, optimal use of scarce renewable power likely 1) decarbonising grid electricity, 2) supplying hydrogen for end-uses which are likely to be permanent.
- **Gas quality:** Some industrial gas end-use applications require high gas quality, blending hydrogen into the grid could disrupt these industrial processes.
- **Consumer costs:** Given hydrogen's higher production cost in the short term blending could result in an increase of consumer costs.<sup>3</sup>

NOTES: <sup>1</sup> 5-20% blending of hydrogen into the grid reduces CO<sub>2</sub> emissions from combustion of the gas blend by less than a third (ca. 2-7%). <sup>2</sup> Different nations currently have maximum hydrogen blending limits. <sup>3</sup> Impact on end-consumer prices will vary according to the relative prices of natural gas and hydrogen and level of pass through to end-consumers, for example: i) blending 5% hydrogen (by volume) at a hydrogen price of \$2/kg and natural gas price of \$6.5/MMBtu (e.g., UK) increases the costs by ca. 3% (assuming direct pass-through of cost premium from producer to consumer), ii) at a higher hydrogen price (\$3/kg) and lower natural gas price \$3/MMBtu (e.g., USA) the cost of blending increases by ca. 13%.

SOURCES: BloombergNEF (2019). Hydrogen – the economics of space and water heating; Industry interviews.

23 Siemens (2021), *Power-to-X: the crucial business on the way to a carbon-free world*.

24 ETC (2021), *Making Clean Electrification Possible: 30 years to electrify the global economy*

25 Blast furnaces can use up to 20% clean hydrogen, above which a DRI facility is required. The grey hydrogen production of ammonia plants and refineries needs to be retrofitted with CCS or fully exchanged with green hydrogen to enable full decarbonisation.

26 Embrittlement concerns are relevant for specific types of steel pipelines and a range of solutions are being explored to overcome this issue (e.g., applying an inner coating to protect the steel), alongside research to assess the long-term material stability of all types of pipeline materials (e.g., NREL HyBlend project). Solutions to overcome embrittlement challenges will vary according to capacity requirements, status of existing pipelines and cost trade-offs. Early conversion pilot projects in Germany and the Netherlands have shown that existing pipelines do not require internal coatings, while studies suggest that this will likely be required in France. Source: NREL (2013), *Blending Hydrogen into Natural Gas Pipeline Networks: A Review of Key Issues*; Guidehouse (2020), *European Hydrogen Backbone*.

this blending to 5-20% by volume (see Annex for further discussion).<sup>27</sup> Major retrofits of gas grids and appliances would be essential to support higher concentrations (including up to 100%).<sup>28</sup> Industrial end users of natural gas (e.g., petrochemical sector) would be particularly affected by low-level hydrogen blending in the grid as it lowers the purity of the natural gas feedstock inputs.

**Possible uses where relative advantages versus other decarbonisation options are still unclear** – as electrification technologies are still improving and technical/cost breakthroughs that would impact their competitiveness versus hydrogen are likely but not certain – include:

- **Long-distance trucking, long-distance buses, rail and forklift trucks.** Dramatic falls in the price of lithium-ion batteries, and steady improvements in battery energy density and charging times (both past and prospective) have widened the distance and size ranges across which BEVs can compete with hydrogen FCEVs. This is especially true for business models and routes where overnight depot charging is possible. However, FCEVs may play a significant role over long distances, in particular in cases where trucks seldom return to depots overnight, in locations where high-capacity charging points cannot be installed, or for energy-demanding applications (e.g., high loads, refrigerated trucks). Hydrogen-powered trains may also play a role in long-distance rail connections where overhead electrification is too expensive.<sup>29</sup> Hydrogen-powered forklifts compete with BEVs in some applications because of (i) higher tolerance of low temperatures and (ii) faster recharge than BEVs.<sup>30</sup> Similarly, high-power mining machinery and trucks and airport ground support equipment may also offer a niche opportunity.
- **Residential heating**, where the optimal decarbonisation solution will depend on local specificities. In newly built and many refurbished environments, electrification (in particular if using heat pumps) is certain to be more efficient (potentially 5-6 times<sup>31</sup>) and lower cost than using piped hydrogen in hydrogen boilers. Where existing heating is currently provided via natural gas and direct electrification is not feasible (e.g., due to poor building insulation), hydrogen combustion could provide a decarbonisation solution; however, it would require significant investment in a dedicated hydrogen grid, with the existing natural gas grids either retrofitted or replaced, and could face considerable public perception and safety challenges.<sup>32</sup>
- **Hydrogen for short-duration power back-up at specific energy-intensive sites**, as it may be competitive to provide power via a fuel cell to cover for power outages in, for example, data centres. For shorter storage durations (e.g., below 4 hours), batteries will likely be the more competitive solution, as economies of scale in the EV sector will drive further cost reductions and higher performance. However, for longer-term back-up, clean hydrogen alternatives may be competitive versus more expensive diesel power generators.<sup>33</sup>
- **High-temperature heat in industrial applications**, such as cement production which requires temperatures above 1000°C. Direct electrification of such heat may eventually be possible, but current projects stand at TRL 4.<sup>34</sup> Sustainable biomass can also be an alternative (e.g., 17% of UK cement production currently uses bioenergy),<sup>35</sup> but total sustainable supplies are likely to be limited (see the forthcoming ETC bio-economy report).<sup>36</sup> In principle, hydrogen can be used to produce very high temperatures, but some studies suggest that its flame is not well suited to cement production in particular, and the continued use of fossil fuels combined with CCS (which will, in any case, be required to capture cement process emissions) may be a cost-effective alternative. Other high-temperature heat processes (e.g., furnaces, boilers, burners in refineries, glass, ceramics industry) may be able to switch to hydrogen, but the precise balance between direct electrification and hydrogen in these sectors remains unclear, with technical innovation required in both routes.<sup>37</sup>

27 5-20% blending by volume represent 2-7% by energy content (given hydrogen's lower volumetric energy density than methane), and therefore a 2-7% reduction in carbon dioxide emissions associated with gas fired building heating. Several pilot projects (e.g., HyDeploy in UK, GRHYD in France) are trialling hydrogen blending into the gas grid. BloombergNEF (2019), *Hydrogen – The economics of space and water heating*.

28 Appliances need to be changed at concentrations above 20%. This includes industrial applications currently using natural gas from the grid.

29 This refers in particular to long-distance rural, low-speed trains with low utilisation, that are currently diesel-powered.

30 According to Interact Analysis, the current penetration of FCEV forklifts is less than 5%, Li-Ion BEV is ca. 15-20%, lead-acid BEV ca. 50% and the rest is internal combustion engine. Source: Interact Analysis (2020), *The forklift truck market now and moving forward*.

31 Achieving ca. 300% via heat pumps compared to ca. 50% for green hydrogen taking the full conversion chain including electrolyser (see Box A). Sources: London Energy Transformation Initiative (2021), *Hydrogen – A decarbonisation route for heat in buildings*; Prof. David Cebon – CSRF (2020), *Hydrogen for Heating*; Fraunhofer IEE (2020), *Hydrogen in the energy system of the future: focus on heat in buildings*.

32 Hydrogen likely to be most attractive for locations in cold climates (where heat pumps are less efficient), no cooling demand (reversible heat-pumps also provide cooling), poorly insulated building stock, poor electricity transmission grid (not capable to provide peak power demand) and a gas distribution grid made of polyethylene capable of using 100% hydrogen (as in Australia and UK). Further details in: ETC (2019), *Sectoral focus – Building Heating*. The Hy4Heat project in the UK is extensively trialling all aspects of 100% hydrogen heating including appliances changes.

33 IEA (2019), *The Future of Hydrogen*.

34 For other industrial applications beyond cement with lower required temperatures, direct electrification of high temperature heat has higher TRL level (e.g. electric arc furnace).

35 MPA et al. (2019), *Options for switching UK cement production sites to near zero CO<sub>2</sub> emission fuel*.

36 ETC (Upcoming, 2021), *Making a Sustainable Bio-Economy Possible*.

37 McKinsey (2020), *Plugging in: What electrification can do for industry*.

- **Plastics and other chemical production**, where hydrogen could be an input in new production processes, such as methanol-to-olefin (MTO) and methanol-to-aromatics (MTA). These processes will also, however, require sustainable CO<sub>2</sub> sources (e.g., derived from direct air capture or, if resources allow, sustainable biomass<sup>38</sup>). In some cases, a combination of increased recycling (reducing the need for primary plastic production) or the direct use of bio-feedstocks (if available given tight sustainable supply<sup>39</sup>) could prove more effective decarbonisation options.

## An illustrative scenario for hydrogen use by mid-century

Our illustrative scenario for hydrogen use in 2050 is shown in Exhibit 1.4. For some sectors, the range of uncertainty is large, but, at an aggregate level, hydrogen use could grow from today's 115 Mt to a maximum of 1000 Mt per annum by mid-century if all use cases materialise. Taking into consideration the uncertainty around some end uses as well as varying projections of energy productivity improvement in the global economy, a range of 500-800 Mt per annum appears most likely (ca. 15-20% final energy demand<sup>40</sup>).

Other climate-aligned studies suggest a similar order of magnitude, but with different precise estimates or assumptions about sectoral mix (Exhibit 1.5). BloombergNEF and the Hydrogen Council assume a greater role for transport applications, including in particular long-distance trucking. The BloombergNEF New Energy Outlook Climate Scenario suggests a larger share for power storage, while the ETC scenario illustrates larger shares for aviation and shipping. These scenarios imply that hydrogen could account for 13-24% of final energy demand by 2050.

Estimates for both hydrogen and direct electricity demand are inherently uncertain. It is important to note, though, that in some sectors – in particular trucking and residential heat, but also shorter-distance aviation and shipping<sup>41</sup> – the uncertainty relates to the balance between hydrogen and direct electrification. As a result, estimates of the total

### Clean hydrogen will play a growing role across the economy as the world transitions towards net-zero

Clean hydrogen demand in a net-zero CO<sub>2</sub> emissions economy (2050, illustrative scenario)  
Million tonnes per year, ETC supply-side decarbonization pathway

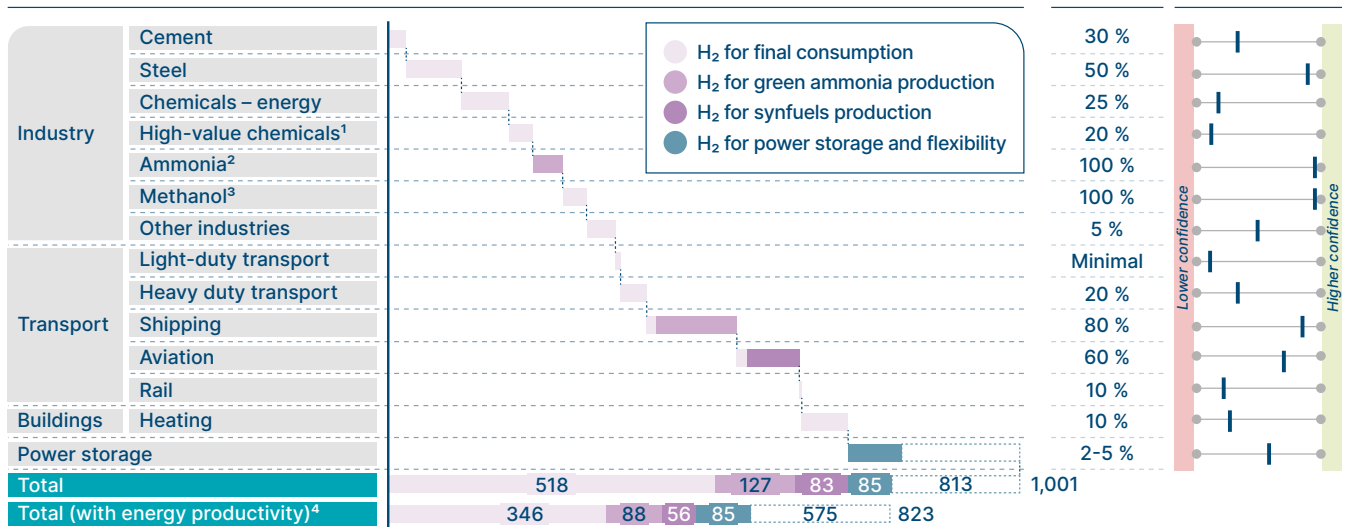

**Level of confidence in role of H<sub>2</sub> in a net-zero CO<sub>2</sub> emissions economy**

**Lower** Multiple decarbonisation routes available, eventual role of hydrogen likely to vary by region depending on local costs and availabilities

**Higher** Hydrogen based routes likely to play a significant decarbonisation role due to, e.g. limits to alternative routes, likely cost evolution, industry actions

**NOTES:** <sup>1</sup> High value chemicals predominantly used to produce plastics, which could potentially be produced via Hydrogen and CO<sub>2</sub> in the future (via methanol and MTO process); <sup>2</sup> Around 80% of ammonia (excl. shipping) is used to produce fertilisers; <sup>3</sup> Methanol is used as intermediate in numerous chemical processes, including plastics production. <sup>4</sup> ETC scenario including maximum energy productivity improvements.

**SOURCE:** SYSTEMIQ analysis for the Energy Transitions Commission (2021)

Exhibit 1.4

38 The CO<sub>2</sub> could also stem from biogenic sources that already exist such as ethanol plants, biogas plants and pulp mills.

39 ETC (upcoming, 2021), *Making a Sustainable Bio-economy Possible*.

40 Including hydrogen and hydrogen derivatives (ammonia, synfuels).

41 The ETC illustrative supply-side decarbonisation pathway applies an energy demand increase for shipping from 2014 to 2050 by ca. 85%. This is highly uncertain given that international trade of energy carriers (LNG, coal, oil), but also commodities (see section 1.4) may be substantially decreased in the future.

required electricity demand by mid-century are considerably less uncertain than those for hydrogen demand and production.<sup>42</sup>

Government and national strategies for hydrogen should therefore assume that hydrogen will play a major role in a zero-carbon economy even if the precise balance of decarbonisation technologies by sector is uncertain.

## Others share this vision for a significantly expanded role of hydrogen, but with different assumptions about sectoral mix

2050 hydrogen demand  
Mt hydrogen / year

● Power ● Building heating ● Industry ● Other Transport ● Road Transport ● Total Transport ● Synfuels production ● Green ammonia for shipping

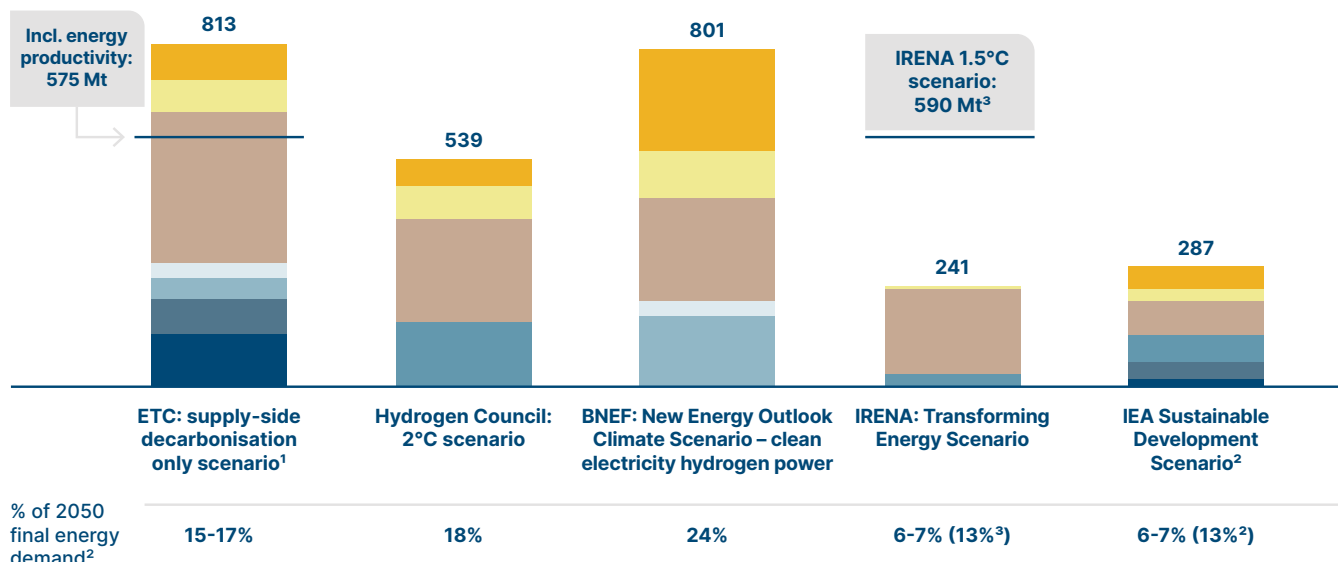

NOTES: <sup>1</sup> Illustrative scenario considering 2050 final energy demand without application of energy productivity levers which would reduce energy needs in a net-zero scenario, <sup>2</sup> Hydrogen reaches 13% of final energy demand by 2070 in IEA SDS, with hydrogen volumes of 520 Mt/year, <sup>3</sup> IRENA 1.5C scenario does not include split in uses, but represents 13% final energy demand.

SOURCES: SYSTEMIQ analysis for the Energy Transitions Commission (2021); Hydrogen Council (2017), *Hydrogen scaling up – A sustainable pathway for the global energy transition*; BloombergNEF (2020), *New Energy Outlook*; IRENA (2021), *World Energy Transitions Outlook – 1.5C Pathway*; IRENA (2020), *Global Renewables Outlook*, IEA (2019), *The future of hydrogen*

Exhibit 1.5

## II. Falling production costs and implications for the cost of decarbonisation

Any hydrogen used in an effort to accelerate decarbonisation must be produced in a clean fashion. This could be via the so-called “green” route – using zero-carbon electricity to electrolyse water. Alternatively, low-carbon (but not zero-carbon) hydrogen can be produced via the “blue” route, deriving hydrogen from methane from natural gas, but applying carbon capture and storage, alongside the minimisation of any methane leakage (a potent greenhouse gas) to almost zero, throughout the natural gas production, processing, transport and use.

In the absence of a carbon price,<sup>43</sup> the blue route will always be more expensive than producing “grey” hydrogen (i.e., from methane or coal but with CO<sub>2</sub> emissions unabated), because by definition it adds a step (the carbon capture and storage) to the underlying production process. By contrast, dramatic potential falls in the price of renewable electricity and electrolyzers mean that, in many locations, green hydrogen costs may undercut grey hydrogen in the medium term. The green production route is therefore likely to dominate in the long term, but with an important role for blue hydrogen in transition and in some specific locations.

<sup>42</sup> The energy will likely either be used directly as electricity or indirectly to make green hydrogen. Assuming the same end use efficiency, the difference in total final electricity demand would only differ by the scale of the losses from electrolysis (ca. 25-35%).

<sup>43</sup> A carbon price of \$10/t CO<sub>2</sub> corresponds to an increase in grey hydrogen production cost of ca. \$0.1/kg hydrogen

As a result, too, the costs of producing clean hydrogen, for volumes far in excess of today's levels, will eventually be small, or potentially negative in relation to grey hydrogen. But it is important to note that using hydrogen in end use applications will in some cases still impose a "green cost premium" versus current high-carbon technologies, with public policy therefore essential to drive the pace of decarbonisation.<sup>44</sup>

## Options for zero-carbon hydrogen production

The vast majority of hydrogen is currently produced via Steam Methane Reforming (SMR) of natural gas or (particularly in China) via coal gasification processes. Only a minute proportion is currently produced in a low/zero-carbon fashion.

There are a range of potential technologies which could deliver very low/zero-carbon hydrogen (see Exhibit 1.6), but many are either still at early stages of development, face inherent disadvantages, or, in the case of methane pyrolysis, can depend on large sales of a "carbon black" by-product to be cost-effective (Exhibit 1.7). Hydrogen production routes from biomass are unlikely to play a major role due to overall limited resources of sustainable biomass; however, they may offer routes towards negative emissions via sequestration of the CO<sub>2</sub>.<sup>45</sup>

### Multiple potential clean hydrogen production pathways; however, two pathways likely to dominate hydrogen scale up in coming decade

Clean H <sub>2</sub> production pathways:				Priority production pathways:	See technical annex for further information	
H <sub>2</sub> Source input	Additional inputs	Process	CCS required? (*neg. emissions)	Green	Blue	
				Reason for prioritization / de-prioritization		
Natural Gas	Power <sup>1</sup> + water	Steam methane reforming (SMR)	+ CCS			Commercially available and deployed in pilots/few commercial plants (<5); commonly employed with only 60 % capture rate today; higher capture rates more expensive
	Power <sup>1</sup> (heat produced in reformer) + water	Autothermal reforming (ATR)	+ CCS			Commercially available and deployed in pilots; typically larger plant scale, high CO <sub>2</sub> recovery rates & lower CCS costs due to concentrated CO <sub>2</sub>
	+ Power <sup>1</sup> + oxygen (no combustion)	Chemical looping	+ CCS			Low TRL (~100kW); no investment from industry
	Power <sup>1</sup> + oxygen	Partial oxidation (POX)	+ CCS			Similar to ATR, commercially available, high CO <sub>2</sub> capture & lower CCS costs, more flexible on feedstock, lower purity hydrogen product
	Power <sup>1</sup> (no oxygen)	Pyrolysis (methane splitting)				Some promising technology at lab/pilot scale; lower TRL; no CO <sub>2</sub> emissions during process; option to sell by-product 'carbon-black'
Liquid hydrocarbons	+ Power <sup>1</sup> + oxygen	Partial oxidation	+ CCS			Upgrading of residual refinery hydrocarbons to hydrogen. Overall smaller volumes with declining role towards mid-century
Coal	+ Power <sup>1</sup> + oxygen + water (partial combustion)	Coal gasification	+ CCS			Lower process efficiency than SMR; higher carbon emissions per kg hydrogen therefore CCS more expensive
Biomass	Power (no oxygen)	Pyrolysis	+ CCS*			Constrained by limited sustainable, low-lifecycle carbon bio-resources
	+ Power + oxygen + water (partial combustion)	Biomass gasification	+ CCS*			Complex processing, more expensive than alternative routes (especially given high biomass collection costs), with low TRL
	Microorganisms (no oxygen)	Bio-chemical				Biomass has lowest hydrogen to carbon ratio from all feedstocks, hence highest CO <sub>2</sub> /H <sub>2</sub> emissions
Biogas	+ Power + water	Biomethane reforming	+ CCS*			However combined with CCS could create "negative emissions" – may have a long-term local role where sustainable biomass available
Water	Power	Electrolysis				Declining costs of renewable power, and equipment costs decline with scale - 'zero-carbon hydrogen' feasible
	+ Nuclear power	Thermochemical water splitting				Low TRL (lab-scale), large advancements in tech required, high cost uncertainty
	Solar power	Solar-chemical water splitting				

NOTE: <sup>1</sup> Power input depends on plant design and CO<sub>2</sub> capture. Power often provided through combustion of fossil input.

Exhibit 1.6

44 The scale of the green cost-premium will be strongly influenced by CO<sub>2</sub> emission prices lowering the competitiveness of fossil fuel technologies.

45 ETC (Upcoming, 2021), *Making a Sustainable Bio-Economy Possible*.



While new technology developments are possible, it is likely that the path to zero-carbon hydrogen will be dominated by one of two technologies:

- **“Green” hydrogen production** via the electrolysis of water is a long-proven technology which accounted for most hydrogen production before natural gas became abundantly available. Several electrolyser technologies are available – alkaline, proton exchange membrane (PEM), and solid oxide electrolyser cell (SOEC) – with different advantages in different specific applications. Technological progress is gradually improving their key performance parameters such as energy efficiency, and flexibility in response to varying electricity load (Box C). The carbon intensity of hydrogen derived from electrolysis depends on the carbon intensity of electricity used in operation, and that of the electrolyser manufacturing process. In principle, it can become zero if all the electricity used comes from zero-carbon sources (Exhibit 1.15). Further information on clean hydrogen standards is described in section 2.6.
- **“Blue” hydrogen production** entails adding carbon capture and storage (CCS) to either SMR, ATR (auto thermal reforming) or POX (partial oxidation) of natural gas. The technologies differ in terms of their ability to achieve high CO<sub>2</sub> capture rates, with at least 90% being considered as minimum for low-carbon hydrogen (further details discussed in technical Annex):
  - SMR + CCS can capture ca. 60% of the produced CO<sub>2</sub> at moderate additional cost and ca. 90% with significant retrofitting and at a significantly higher cost.
  - ATR + CCS and POX + CCS<sup>46</sup> enable significantly higher capture rates beyond 95% at moderate costs and are therefore the more likely technology of choice for greenfield blue hydrogen projects.
  - In addition to capturing CO<sub>2</sub> emissions during the blue hydrogen production, leakages of methane from natural gas during production, transportation, storage, processing and use need to be minimised (see section below and Exhibit 1.14).

## Clean hydrogen production pathways: Methane pyrolysis

The emerging methane pyrolysis pathway is attracting attention as it could potentially use 3-5 times less electricity to produce the same amount of hydrogen compared to water electrolysis (i.e. green hydrogen); however, technical & economic barriers to scaling remain.

<b>Process overview</b>	<ul style="list-style-type: none"> <li>• Natural gas (i.e., methane) heated in the absence of oxygen to <b>produce solid carbon and hydrogen</b> with zero CO<sub>2</sub> emissions from the reaction</li> <li>• Particularly relevant technology in locations with very low cost natural gas but limited CO<sub>2</sub> storage availability</li> <li>• Depending on quality of by-product carbon (e.g. “carbon black”) additional revenues can be generated, however, if the carbon is used (e.g. as filling material for tires) and ultimately combusted, fossil CO<sub>2</sub> will ultimately be released</li> </ul>	<p>Methane <math>\xrightarrow{\text{Heat w/o oxygen (&gt;750 C)}}</math> Hydrogen + Solid carbon  <math>\text{CH}_4 \rightarrow \text{H}_2 + \text{C}</math></p>
<b>Current status</b>	<ul style="list-style-type: none"> <li>• <b>Lower technological readiness level (TRL 6 - IEA)</b> compared to SMR, ATR and electrolysis (TRL 8-9 - IEA)</li> <li>• Different reactor technologies under development (including plasma, molten metal and gas reactors) – difficult to anticipate which/if technology will reach full commercial readiness</li> <li>• <b>Start-ups</b> (e.g. Monolith materials, C-zero, Carbtopia) and <b>established chemical and fossil fuel companies</b> (e.g. BASF, Wintershall DEA, Gazprom) at different stages of pilot and pre-commercial development</li> </ul>	
<b>Cost forecasts</b>	<ul style="list-style-type: none"> <li>• <b>Cost forecasts vary</b>; some studies suggest lower costs than blue hydrogen are feasible: 1-2.5 \$/kg hydrogen (assuming \$10-150/ton carbon black sales price (0.03-0.45 \$/kg hydrogen) and 4 \$/MMBtu natural gas price) while others suggest higher costs than blue hydrogen (\$1.9-2.6/kg hydrogen, assuming no carbon black sales at \$5.2/MMBtu)</li> <li>• Uncertainty around hydrogen cost partly driven by expected sale price of carbon black by-product, however total carbon black market is likely limited, today’s market corresponds to the carbon black generated by only 5.5 Mt of hydrogen produced via methane pyrolysis</li> </ul>	
<b>Limitations / challenges</b>	<ul style="list-style-type: none"> <li>• <b>On-going technical problems: I) Maintaining conversion rate at scale, II) Carbon clogging</b> (overcome at lab-scale through liquid metal reactor process), <b>III) Low purity of hydrogen, IV) Low efficiency (ca. 50%)</b></li> <li>• <b>Residual emissions from methane extraction</b> (see Section 1.2)</li> </ul>	

**SOURCES:** Energy Conversion and Management: X (2020), *Hydrogen and hydrogen-derived fuels through methane decomposition of natural gas – GHG emissions and costs*; EWI (2020), *Estimating long-term global supply costs for low-carbon hydrogen*; Science (2017), *Catalytic molten metals for the direct conversion of methane to hydrogen and separable carbon*; Energy & Environmental Science (2019), *Levelized cost of CO<sub>2</sub> mitigation from hydrogen production routes*, IEA (2020), *ETP Clean Energy Technology Guide*

Exhibit 1.7

<sup>46</sup> ATR and POX are related technologies. In simplified terms, the former is performed at slightly lower temperatures using a catalyst and the latter at higher temperatures without the use of a catalyst. POX is therefore less sensitive to the choice of feedstock (can also be applied to liquid hydrocarbons) and does not need feedstock purification, but generally yields less pure hydrogen if no further purification steps are performed. Further details are discussed in the appendix.

## Alkaline electrolyzers are lowest cost; whilst PEM have advantages in faster response times (to variable electricity supplies) and smaller footprint

	Alkaline Electrolyser	PEM Electrolyser	SOEC Electrolyser
<b>Commercial status</b>	Mature	Commercial, fast growth	Demonstration plants
<b>Electrolyser electrical efficiency % LHV</b>	Today		
	2030		
	Long term		
<b>Operating temperature (°C)</b>	60 – 80	50 – 80	650-1,000
<b>Plant footprint m<sup>2</sup> / kW</b>	0.095	0.048	-
<b>Characteristics</b>	<ul style="list-style-type: none"> <li>Slower dynamic response<sup>1</sup></li> </ul>	<ul style="list-style-type: none"> <li>Faster dynamic response</li> </ul>	<ul style="list-style-type: none"> <li>Highest efficiency, no cycling<sup>2</sup></li> </ul>
<b>Implications</b>	<ul style="list-style-type: none"> <li>Less well suited to <b>intermittent power supply</b> (e.g. renewables) – likely to be overcome by innovation for faster ramping and batteries to smooth short term variations.</li> </ul>	<ul style="list-style-type: none"> <li>Well suited to a <b>variable electricity supply</b> (e.g. intermittent renewables)</li> <li>Suitable for voltage regulation services</li> </ul>	<ul style="list-style-type: none"> <li>Potentially well suited for <b>constant base-load H<sub>2</sub> production</b> in future</li> <li>Only technology to reverse function and able to work as fuel cell to produce electricity</li> </ul>
<b>Stack lifetime (2030)</b>	90,000 – 100,000	60,000-90,000	40,000-60,000
<b>Major producers (non-exhaustive)</b>	Suzhou Jingli, Thyssenkrupp, Nel	Siemens, ITM Power, Cummins	Haldor Topsøe, Ceres, Sunfire

Box C

NOTES: <sup>1</sup> Lab research by NREL on 40kW systems indicates slower ramp up/down times vs. PEM, alkaline can still complete more than 90% of the ramp range within 0.2 seconds. <sup>2</sup> Cycling refers to the ramp-up/down of the electrolyser. SOEC need to continuously run at high temperatures and can therefore not be ramped-up and down.

SOURCES: BloombergNEF (2021), *1H2021 Hydrogen Market Outlook*; IEA (2019), *The Future of Hydrogen*; Science (2020), *Recent advances in solid oxide cell technology for electrolysis*; IRENA (2020), *Green hydrogen cost reduction*; NREL(2014), *Novel Electrolyser Applications: Providing More Than Just Hydrogen*

## Potential for cost reductions: very large for green, more limited for blue

Blue hydrogen production costs are currently below those for green hydrogen, and the production of grey hydrogen (SMR without CCS) is cheaper still. Exhibit 1.8 shows estimates for each, with green hydrogen costing about \$3-5/kg, blue around \$2/kg and grey around \$1.5/kg in average locations.<sup>47,48</sup> However, green production costs have the potential to decrease drastically and fall below grey costs in some locations, while blue costs are not expected to decrease significantly.

Green hydrogen costs depend mainly on two factors – the cost of zero-carbon electricity, and the capital cost of electrolyzers.<sup>49</sup> Both are likely to fall dramatically (Exhibit 1.9):

- The levelised cost of renewable electricity has fallen by 70-90% over the last decade, with recent auctions producing prices below \$15/MWh in some locations, and with further cost declines inevitable (see ETC clean electrification report for more details).<sup>50</sup>

47 Blue hydrogen costs today illustrate SMR+CCS with 90% capture rate. There are two currently operational plants with SMR+CCS at 60 % capture rate. While ATR and POX are commercially used, there is no existent dedicated blue hydrogen production facility, therefore the lower costs for ATR + CCS and POX + CCS are only considered relevant in ca. 5-10 years.

48 Prices within this report reference dollar valuation in US\$2019.

49 The capacity utilisation factor (i.e. how many hours the electrolyser is running) at the given cost of electricity and the electrolyser efficiency are other factors introduced in more detail in section 2.1. Green hydrogen may also offer additional small revenue streams (\$0.1/kg hydrogen) from its oxygen and heat by-product. Source: Material Economics (2020), *Mainstreaming green hydrogen in Europe*.

50 The relevant costs of electricity are dependent on the type of source (e.g., grid, dedicated) and laid out in chapter 2. Sources: ETC (2021), *Making Clean Electrification Possible: 30 years to electrify the global economy*; IRENA (2020), *Green hydrogen cost reduction*.



- Electrolyser costs, which in Exhibit 1.10 are assumed to be around \$850/kW<sup>51</sup>, can be dramatically reduced as the industry achieves economy of scale and learning curve effects. Electrolyser costs of \$300/kW are already available in China<sup>52</sup>, and reasonable estimates suggest that electrolysers could be widely available for \$200/kW by 2030 and \$100/kW by 2050.<sup>53</sup>
- As a result, green hydrogen could reach below \$1/kg in favourable locations (i.e., with access to favourable, low-cost variable renewable energy generation) by 2050, falling below \$2/kg during the 2020s. How rapidly costs decline will depend on the pace of the quantitative ramp-up described in Chapter 2, but several projects have already been launched aiming for below \$2/kg, and in one case \$1.5/kg, within the next decade (Exhibit 2.1).

## Today's production prices range based on local costs: clean production routes more expensive with green hydrogen ca. 2-4x more expensive than grey

Hydrogen production cost (2020)  
\$/kg H<sub>2</sub>

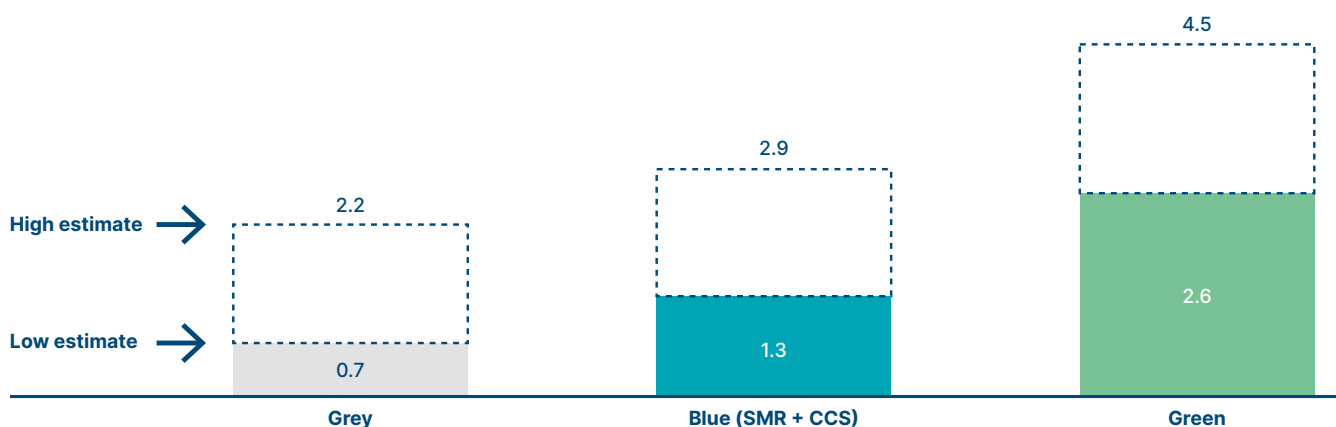

Natural gas and electricity price:

\$1-10/MMBtu

\$25-60/MWh

**NOTES:** No carbon tax applied. Costs for SMR+CCS (90% capture rate) shown as there are no dedicated ATR (or POX) + CCS facilities for blue hydrogen production today. Green: assumed 50% capacity utilisation factor, \$850/kW CAPEX for large scale alkaline electrolyser, energy consumption: 53 kWh/kg. Green hydrogen costs can even be higher for smaller scale applications.

**SOURCE:** SYSTEMIQ analysis for the Energy Transitions Commission (2021); BloombergNEF (2020), *Hydrogen Economy Outlook*

Exhibit 1.8

<sup>51</sup> Based on expert interviews and BloombergNEF (2021), *1H2021 Hydrogen Market Outlook*.

<sup>52</sup> These costs include balance of plant (including power supply, compression and purification) and installation costs (including contingency and other soft costs) within China. These costs are not currently available outside of China mainly due to higher installation costs and lack of trading relationships. They may require higher maintenance costs, but lower CAPEX is worth trade-off of higher maintenance costs in China. Source: BloombergNEF (2020), *Hydrogen Economy Outlook*.

<sup>53</sup> This illustrative cost figure from Bloomberg NEF includes full installation costs for a large scale (>20 MW) alkaline electrolyser including stack, balance of plant (power electronics for voltage transformation, hydrogen purification and compression), construction and mobilisation and soft costs (project design, management, overhead, contingency and owners cost). There are significant differences in electrolyser CAPEX forecasts related to differences in definitions of what is included/excluded in quoted figures and differences in system size (costs decline significantly with order and module size – see Box E). Hydrogen Council suggests electrolyser CAPEX could drop to about \$200-250/kW at the system-level (including electrolyser stack, voltage supply and rectifier, drying/purification and compression to 30 bar). These costs do not include installation and assembly, building, indirect cost. IRENA similarly excludes those cost components and forecasts ca. \$360/kW in their Transforming Energy Scenario by 2030, including stack, rectifier, water purification, hydrogen gas compression and storage and cooling components. Sources: BloombergNEF (2019), *Hydrogen – Economics of production from renewables*; BloombergNEF (2021), *1H2021 Hydrogen Market Outlook*; Hydrogen Council (2021), *Hydrogen Insights*; IRENA (2020), *Green hydrogen cost reduction*; Expert interviews.

# Green hydrogen from electrolysis likely to become cheapest clean production route in the long term, in favourable locations it could be competitive with blue in the 2020s

Cost of hydrogen production from different production routes (excluding transport & storage costs)  
\$/kg H<sub>2</sub>

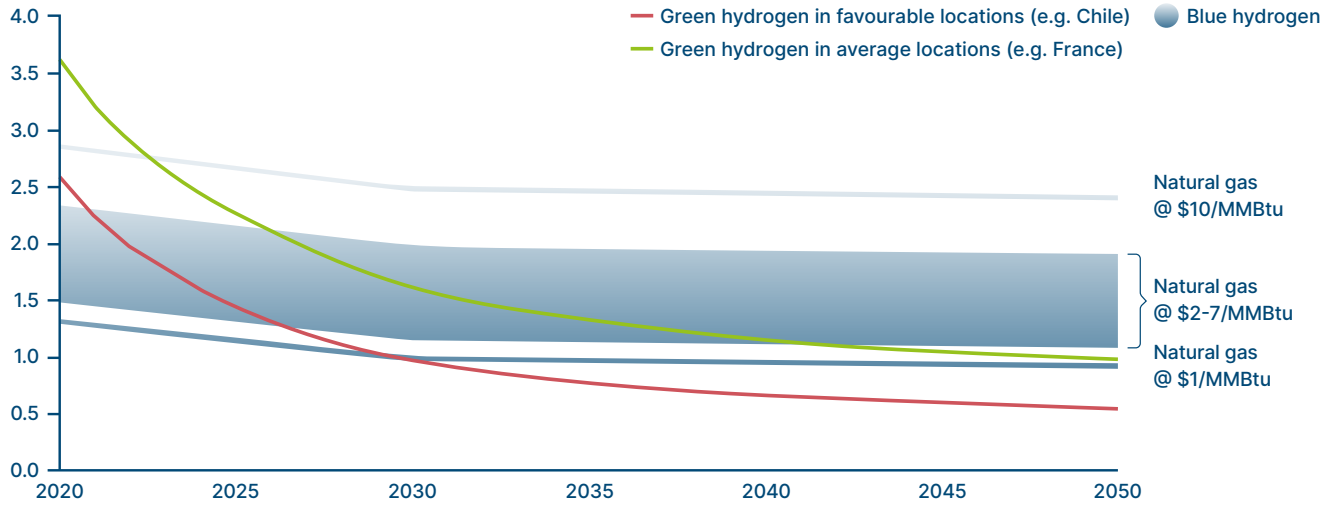

**NOTES:** Blue hydrogen production: i) forecast based on SMR+CCS costs (90% capture rate) in 2020 transitioning to cheaper ATR+CCS technology in the 2020s; Green hydrogen production: i) favorable scenario assumes average LCOE of PV and onshore wind of lowest 33% locations (falling from \$22/MWh in 2020 to \$10/MWh in 2050) and average scenarios assumes median LCOE from lowest 75% locations (falling from \$39/MWh in 2020 to \$17/MWh in 2050) from BloombergNEF forecasts, ii) additional 20% (favorable) and 10% (average) LCOE savings included due to directly connecting dedicated renewables to electrolyser, iii) 18% learning rate for favorable & 13% for average scenario. Electrolyser capacity utilization factor: 45%. Comparison to BloombergNEF most favorable (\$0.55/kg) and average (\$0.86/kg) and Hydrogen Council favorable (ca. \$0.85/kg) and average (ca. \$1.45/kg) in 2050.

**SOURCE:** BloombergNEF (2021), *Natural gas price database* (online, retrieved 01/2021), BloombergNEF (2020), *2H 2020 LCOE Data Viewer*; BloombergNEF (2021), *1H2021 Hydrogen Levelised Cost Update*; Hydrogen Council (2021), *Hydrogen Insights*

Exhibit 1.9

# Green hydrogen production costs are expected to fall driven by both falling cost of electrolysers and continued declines in renewable electricity prices

Fully installed system capex forecast of large alkaline electrolysis projects  
US\$/kW

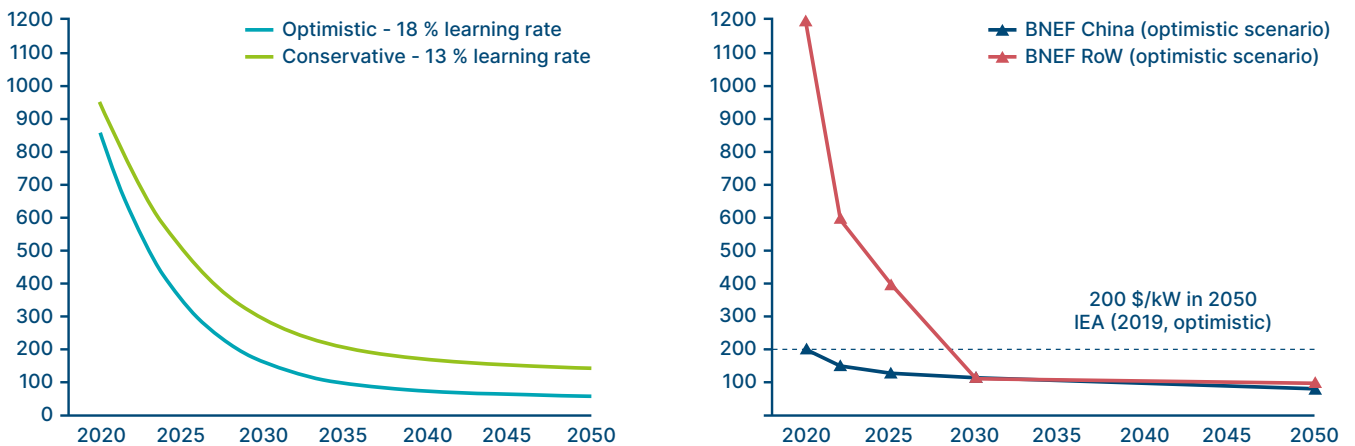

Electrolyser capacity (GW)	15	225	1300	3300	5500	7800
----------------------------	----	-----	------	------	------	------

**NOTES:** CAPEX figures include full installation costs for a large scale (>20 MW) alkaline electrolyser including stack, balance of plant (power electronics for voltage transformation, hydrogen purification and compression), construction and mobilisation and soft costs (project design, management, overhead, contingency and owners cost). There are significant differences in electrolyser CAPEX forecasts likely related to differences in definitions of what is included/excluded in quoted figures and differences in system size (costs decline significantly with order and module size). Hydrogen Council suggests electrolyser CAPEX could drop to about \$200-250/kW (IRENA: \$360/kW in Transforming Energy Scenario) by 2030 at the system-level but do not include installation and assembly, building, indirect cost.

**SOURCES:** BloombergNEF (2019), *Hydrogen – Economics of production from renewables*; BloombergNEF (2021), *1H2021 Hydrogen Market Outlook*; Hydrogen Council (2021), *Hydrogen Insights*; IRENA (2020), *Green hydrogen cost reduction*; Expert interviews.

Exhibit 1.10



Blue hydrogen costs are bound to exceed grey hydrogen costs at no carbon price since they require the addition of CCS to the underlying SMR or ATR process. A carbon price of \$50-70/tonne of CO<sub>2</sub> would make blue hydrogen with 90% capture rate cost-competitive with grey hydrogen.<sup>54</sup> Costs will tend to reduce as scale increases, but at a much slower rate than for green production:

- Reforming technologies (SMR, ATR, POX) are mature and already deployed at scale, limiting the potential for further cost reduction.<sup>55</sup>
- CCS capital costs contribute approximately 50% of a blue hydrogen plant cost and could potentially be reduced by 50%,<sup>56</sup> but this only has a limited impact on total production costs which are heavily influenced by the energy inputs (natural gas) to the blue hydrogen process.
- In total, blue hydrogen costs are forecast to decline only 5-10% by 2050.

Relevant blue hydrogen costs will also reflect the choice between the SMR and ATR technologies, and whether SMR plants already exist or are newly built (Exhibit 1.11, further details in appendix).

- On a newbuild basis, ATR and POX plus CCS costs (achieving a 95%+ capture rate) offer similar costs and will be significantly below (10-15%) the cost of SMR plus CCS to achieve a 90% capture rate.
- Where SMR plants already exist, it may be economic in some circumstances to retrofit CCS. While it is possible to reach 60% capture rate with small retrofits, this is insufficient to be considered 'clean hydrogen.' Retrofits to achieve higher capture rates are more expensive and require significant changes. In many cases, it would be more sensible to switch to greenfield ATR/POX (or green hydrogen).
- ATR/POX (and to a more limited extent SMR) plus CCS will therefore play a cost-effective role in the decarbonisation of already existing hydrogen facilities (noting that this could require investments into new production facilities), and also in new greenfield plants in some very-low-cost gas regions.

## New build ATR + CCS cheaper than SMR + CCS (new or retrofit) at high capture rates

Blue Hydrogen production costs with >90 % CO<sub>2</sub> capture rate (2020s)<sup>1</sup>  
 LCOH, \$/kg

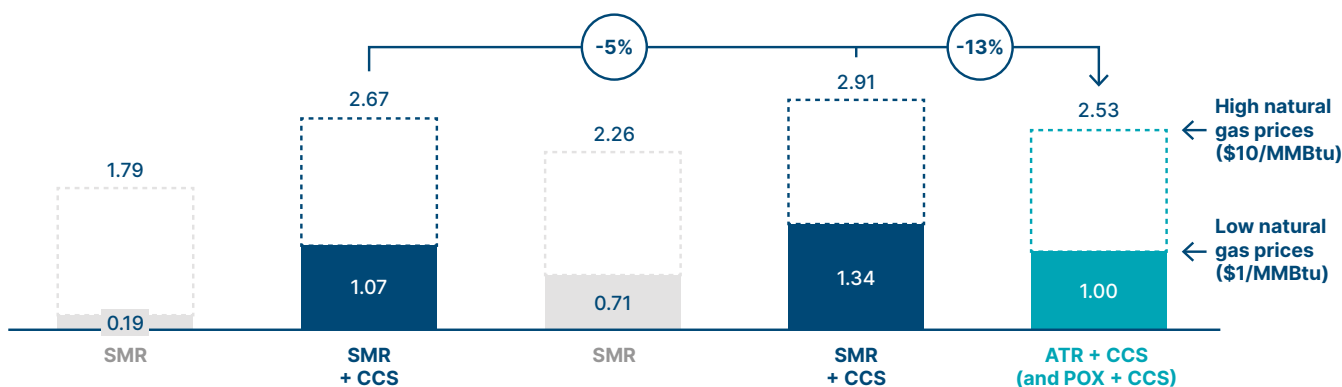

Marginal cost	Retrofit	Levelized cost (new built facility)	
>90% CO <sub>2</sub> capture \$/ton <sub>CO<sub>2</sub></sub>	85	-	80
CO <sub>2</sub> transport and storage \$/ton <sub>CO<sub>2</sub></sub>	25	-	25
Total CCS cost \$/kg H <sub>2</sub>	0.88	-	0.63

NOTES: <sup>1</sup> SMR+CCS ca. 90% CO<sub>2</sub> capture costs, ATR+CCS ca. 95% CO<sub>2</sub> capture costs. ATR and POX plant size ca. 500 t/day. SMR plant size ca. 350 t/day. Low estimate: \$11/MMBtu, high estimate: \$10.3/MMBtu. Retrofit CO<sub>2</sub> capture costs are expected to be slightly higher than for greenfield plants due to significant retrofitting needs and bespoke nature.

SOURCE: BloombergNEF (2020), *Hydrogen – the economics of production from fossil fuels*; BloombergNEF (2019), *Hydrogen: Making green ammonia and fertiliser*; IEA (2019) – *The future of hydrogen*; Cadent (2018), *H21 North of England*; Element Energy (2018), *Hydrogen supply chain evidence base*; Expert interviews

Exhibit 1.11

54 Hydrogen Council (2021), *Hydrogen Insights*; BloombergNEF (2020), *Hydrogen – The Economics of Production from Fossil Fuels with CCS*.

55 Early projects for blue hydrogen production with ATR+CCS will be smaller scale (ca. 300MW) with larger projects (ca. 1500 MW) offering further cost-savings.

56 CCS contributes almost 50% of CAPEX for an SMR+CCS project. For blue hydrogen cost, CO<sub>2</sub> capture is the largest cost component (ca. \$50-70/ton CO<sub>2</sub>), followed by transport (\$1-10/ton) and storage (\$1-7/ton). The biggest savings are expected to stem from the capture process. Source: BloombergNEF (2020), *Hydrogen – The economics of production from Fossil Fuels with CCS*.

**Beyond costs, the green and blue production processes** themselves present different benefits and challenges for clean hydrogen use:

- Blue hydrogen is produced in a steady state flow essential for industrial processes, while green hydrogen production, depending on the load hours, may run intermittently and thus require greater use of storage.<sup>57</sup>
- The high purity of hydrogen produced from electrolyzers is essential for PEM fuel cells in transport applications. To reach the same purity hydrogen via the blue production process, additional purification steps and costs are required.
- Installation of renewable generation is often delayed by land purchasing, planning and permitting processes; however, similar challenges are likely to be associated with the development of CCS for blue hydrogen which requires extensive permitting procedures.
- Land area requirements for renewable electricity production may constrain green production in very densely populated countries.

## The long-term balance – green dominates except where gas prices are very low

In the long run, green hydrogen is likely to dominate in most locations, falling below the price of grey hydrogen in regions with very-low-cost renewables. There may still be a significant role for blue production in regions enjoying very low gas prices, provided methane leakage is dramatically reduced.<sup>58</sup>

Exhibit 1.12 presents a projection for the costs of blue and green hydrogen by region in 2050, with each subject to a range reflecting the cost of zero-carbon electricity (for green) and the cost of gas (for blue). In most locations, green is likely to be more cost-effective, but in regions with very low gas prices – such as Saudi Arabia, the UAE, and the US – blue production may continue to be competitive with green.<sup>59</sup>

It is essential, however, that blue hydrogen is only deployed in a fashion which enables near total capture of CO<sub>2</sub> and in circumstances where methane leakage in the natural gas supply chain is reduced far below today's average levels. Exhibit 1.13 shows estimates of the implications of uncaptured CO<sub>2</sub> and methane leakage for the tonnes of CO<sub>2eq</sub> of GHG produced by blue hydrogen production.

- Even with 95% capture, uncaptured CO<sub>2</sub> would amount to 0.4 tonnes per tonne of hydrogen produced.<sup>60</sup>
- If methane leakage were 1.5% (the current estimated average for the global natural gas industry)<sup>61</sup>, this could add another 3 tonnes of CO<sub>2eq</sub> per tonne of blue hydrogen<sup>62</sup>.

This would imply over 2 Gt of CO<sub>2eq</sub> emissions per annum if all of the 800 Mt of hydrogen predicted for 2050 were produced in a blue fashion (at a 95% capture rate with 1.5% methane leakage). If 15% of 800 Mt hydrogen per year are produced via the blue route, at a capture rate of 95%, ca. 50 Mt of uncaptured CO<sub>2</sub> emissions are produced, in addition at 0.1 % methane leakage rate an additional ca. 25 Mt CO<sub>2eq</sub> would be released. Any production of blue hydrogen must therefore be combined with commitments to capture more than 90% of CO<sub>2</sub> emissions and reduce methane leakage to very low levels – e.g., 0.05%.<sup>63</sup>

57 The storage requirement for green hydrogen adds ca. 0.05 \$/kg (salt cavern) to 0.12 \$/kg (rock cavern) of storage costs in 2050 if 50 % of the produced hydrogen is stored at some point.

58 Methane is the main component in natural gas and a very potent greenhouse gas (84 times stronger warming effect than CO<sub>2</sub> on a 20 year time-scale). During production, processing, transportation and end use of natural gas, small amounts (currently 1.5%) of methane leak and contribute significantly to the overall greenhouse gas emission equivalent lifecycle emissions of the process. Today's methane emissions from the oil&gas sector are equivalent to 7 Gt compared to ca. 35 Gt total CO<sub>2</sub> emissions of the energy sector. Further details will be discussed in a forthcoming ETC publication on negative emissions. Sources: IEA (2020), *Methane Tracker*; IEA (2020), *Global CO<sub>2</sub> emissions in 2019*.

59 Blue may also play a role where renewable resources are costly (due to lack of favourable resources or space constraints) and the cost of importing low-cost green hydrogen from neighbouring regions prohibitive.

60 Higher capture rates are potentially feasible as trialled in the HyNet project in the UK (ca. 97%). See Annex for further discussions on capture rates of blue hydrogen production.

61 Total methane emissions of natural gas sector: 45 Mt. Source: IEA (2020), *Methane Tracker*.

62 With a carbon dioxide emission equivalence factor of 84 (20-year basis)

63 This is considered today's best-in class methane leakage rate according to MiQ's independent methane emissions certification. Reducing leakage to 0.2% is the current ambition of the Oil & Gas Climate Initiative. Sources: MiQ, *Certification and Methane Emissions in EU Import Regulations*; OGCI (2021), *OGCI position on policies to reduce methane emissions*

# By 2050 green production likely to cost less in most locations, but in some very low cost natural gas regions there could be a longer term role for blue production

Cost of green and blue hydrogen production in 2050 (excluding transportation & storage)  
\$/kg H<sub>2</sub>

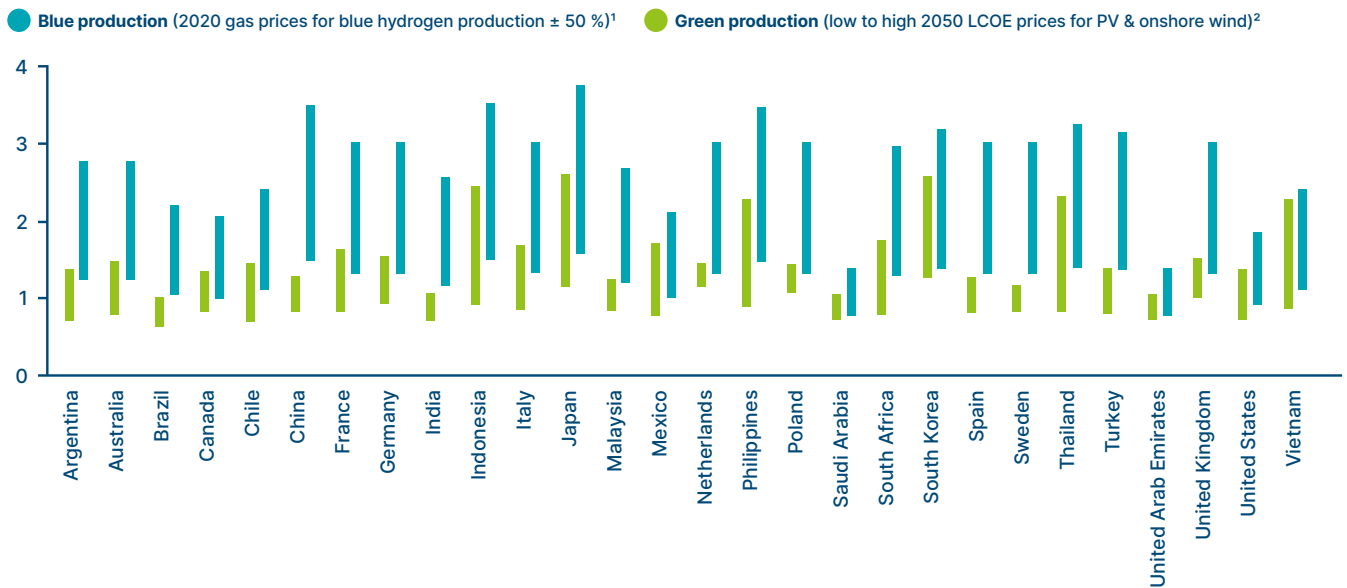

NOTES: <sup>1</sup> Blue production: i) 90% CO<sub>2</sub> capture rate, ii) minimum costs: ATR + CCS at 50% below 2020 gas price, maximum costs: SMR+CCS at 150% of 2020 gas price  
<sup>2</sup> Green production: i) electrolyser CAPEX \$200/kW, 45 kWh/kg energy consumption, follows BNEF assumption of additional 20% reduction of LCOEs due to dedicated renewables connection and additional economics of scale effects due to hydrogen economy development, ii) minimum: load factor PV (32%), onshore wind (48%), maximum: load factor PV (24%), onshore wind (40%).

SOURCE: BloombergNEF, 2H2020 LCOE Data Viewer and 2020 gas prices from natural gas price database (online, retrieved 01/2021)

Exhibit 1.12

# Total GHG emissions from blue hydrogen include both CO<sub>2</sub> from production and methane leakage from natural gas production and transport

Total green house gas emissions of blue hydrogen (with 95% CO<sub>2</sub> capture rate during production)  
kg<sub>CO<sub>2</sub>eq</sub>/kg<sub>H<sub>2</sub></sub>

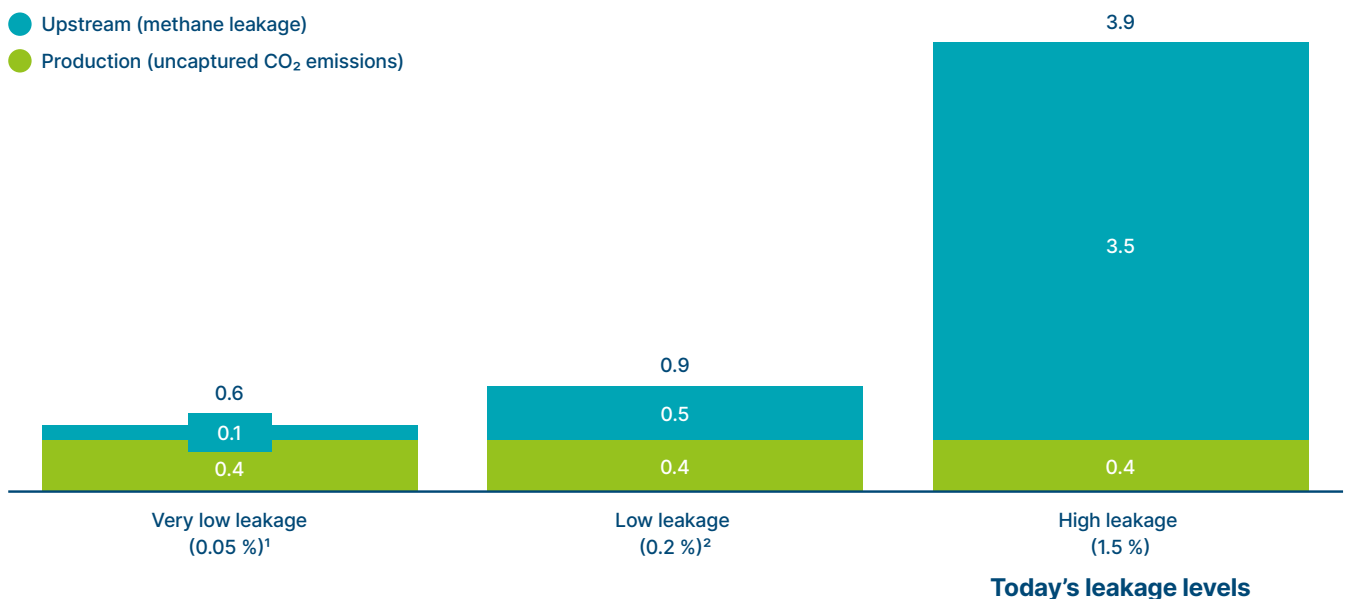

NOTES: Assumes 95% CO<sub>2</sub> capture rate during production. <sup>1</sup> considered best-in class today by MiQ. <sup>2</sup> Ambition set by Oil and Gas Initiative (OGCI). Global warming potential of methane on short-term (20 years) used (GHG emissions factor 84).

SOURCES: IEA (2020), Methane tracker; MiQ; OGCI (2021) - OGCI position on policies to reduce methane emissions

Exhibit 1.13



Green hydrogen will also entail some residual CO<sub>2</sub> emissions, if the electricity used in operation and electrolyser manufacturing still involves some CO<sub>2</sub> emissions. But, in principle green hydrogen can be made truly zero-carbon if all electricity used is also zero-carbon in the entire supply chain (see section 2.6 on carbon accounting and certification schemes for clean hydrogen). The parallel ETC clean electrification report describes the feasibility of decarbonising the power sector and expanding clean electricity use over the next 30 years in detail.<sup>64</sup>

Exhibit 1.14 shows estimates from the Hydrogen Council of possible residual emissions from blue and green hydrogen in 2030 and 2050. It illustrates that, even if complete electricity decarbonisation has not yet been achieved, and even with greatly reduced methane leakage, green production will result in much lower residual emissions than blue.

## Upstream natural gas production, methane 'leakage', and capture rates drive bulk of emissions, green hydrogen lower GHG impact even where full grid decarbonisation yet to be achieved

Life-cycle GHG emissions of hydrogen production routes (2050)

kg/kg<sub>H<sub>2</sub></sub>,LHV

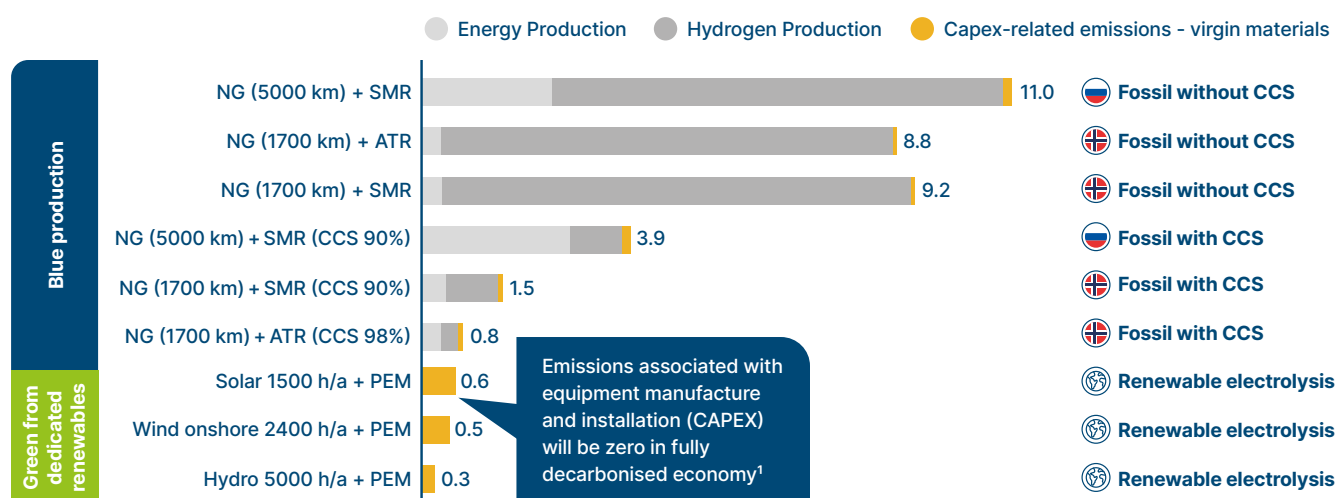

**NOTE:** Energy production category includes upstream methane emissions; equals leakage rates of ca. 0.15-1.2% based on natural gas source and transport distance; H<sub>2</sub> production refers to process emissions from SMR/ATR; <sup>1</sup> GHG emissions for CAPEX due to carbon emissions associated with grid electricity used to manufacture equipment.

**SOURCE:** Adapted with permission from Hydrogen Council and LBST(2021), *Hydrogen decarbonization pathways – A life-cycle assessment*

Exhibit 1.14

64 ETC (2021), *Making Clean Electrification Possible: 30 years to electrify the global economy*.



## The green cost premium in end use application – large at product level, but small for consumers

The potential for green hydrogen cost reduction is likely so significant that, in the medium term, green costs may fall below grey in some locations and be only slightly higher in others. As a result, producing hydrogen in a zero-carbon fashion will not impose a large cost on the economy in the long run.

However, it is important to recognise that using hydrogen in some applications (rather than continuing to use unabated fossil fuels) will sometimes impose significant cost, implying a material abatement cost per tonne of CO<sub>2</sub> saved. This cost differential is due to the remaining cost differential between hydrogen and fossil fuels (in the absence of a carbon price) and to the capital expenditure triggered by the switch to hydrogen-based technologies.<sup>65</sup> Thus, for instance (Exhibit 1.15):

- Even if green hydrogen is available at \$1/kg, green ammonia to power ship engines could cost 55% more than heavy fuel oil.<sup>66</sup>
- Synthetic jet fuel might cost 65% more than conventional jet fuel.

At the intermediate product level, there will therefore be a significant “green product premium” when applying hydrogen to achieve decarbonisation (Exhibit 1.16). Near-zero CO<sub>2</sub> steel (whether achieved via hydrogen direct reduction or CCS) is likely to represent a premium of +40% per tonne of crude steel and ship freight rates could increase by 60% or more.

Therefore, even at very low cost of hydrogen (\$1/kg), explicit carbon taxes or implicit carbon pricing through other forms of regulation (see Chapter 3) will be required to fully close the cost gap between clean hydrogen and existing fossil technologies at the intermediate product level (Exhibit 1.17).

### Even at very low clean hydrogen costs (e.g. \$0.5/kg), majority of hydrogen technologies more expensive than current fossil technologies

<sup>1</sup> ‘Low carbon’ premium for products produced with clean hydrogen vs. existing fossil solution<sup>1</sup>  
%, increase/decrease compared with fossil solution

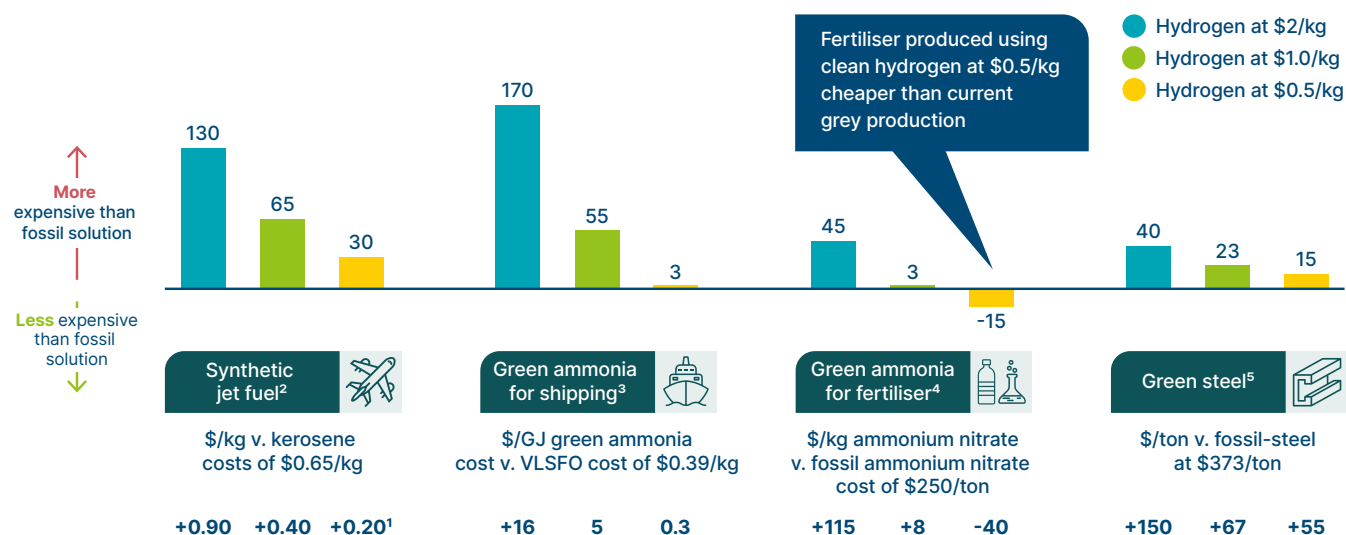

**NOTES:** <sup>1</sup> Cost premium calculated with illustrated delivered hydrogen cost. If close to 0, no premium would be required. <sup>2</sup> CO<sub>2</sub> feedstock cost of \$215/ton. SAF production cost compared to kerosene market price. <sup>3</sup> Green ammonia production cost compared to very low sulphur fuel oil (VLSFO) market price. <sup>4</sup> Compared to ammonium nitrate production cost. <sup>5</sup> Hydrogen-DRI combined with electric arc furnace compared to production cost of coke-fired blast-furnace with basic oxygen furnace fossil steel.

**SOURCES:** World Economic Forum and McKinsey for Clean Skies for Tomorrow (2020) - *Sustainable Aviation Fuels as a Pathway to Net-Zero Aviation*; Expert interviews

<sup>65</sup> The hydrogen ‘cost premium’ is only partially related to lower technological readiness of hydrogen use cases and will persist in some sectors when hydrogen technologies are fully developed and production costs have decreased.

<sup>66</sup> The reference shipping fuel price (\$0.39/kg) is calculated as an average across Top 20 global bunker ports from Jan 1st 2020 to July 31st 2020. The VLSFO (very-low sulphur shipping fuel oil) price fluctuates significantly (between \$0.2-0.7/kg in the last 1.5 years) and lower cost premiums may be feasible at higher fuel costs: VLSFO cost above \$0.6/kg would reduce the cost premium to almost zero at \$1/kg hydrogen.

Despite the cost increase at the intermediate level, Exhibit 1.16 also shows that, in most sectors, the “green consumer premium” – i.e., how much more consumers will need to pay for the products and services they directly purchase – will still be trivial since intermediate products or services account for only a very small proportion of total end-product cost (and even more so of final consumer price). For instance, decarbonising steel will add less than 1% to the cost of a car,

## Use of clean hydrogen would have a significant impact on the price of intermediate products, but a negligible impact on final product prices in most sectors

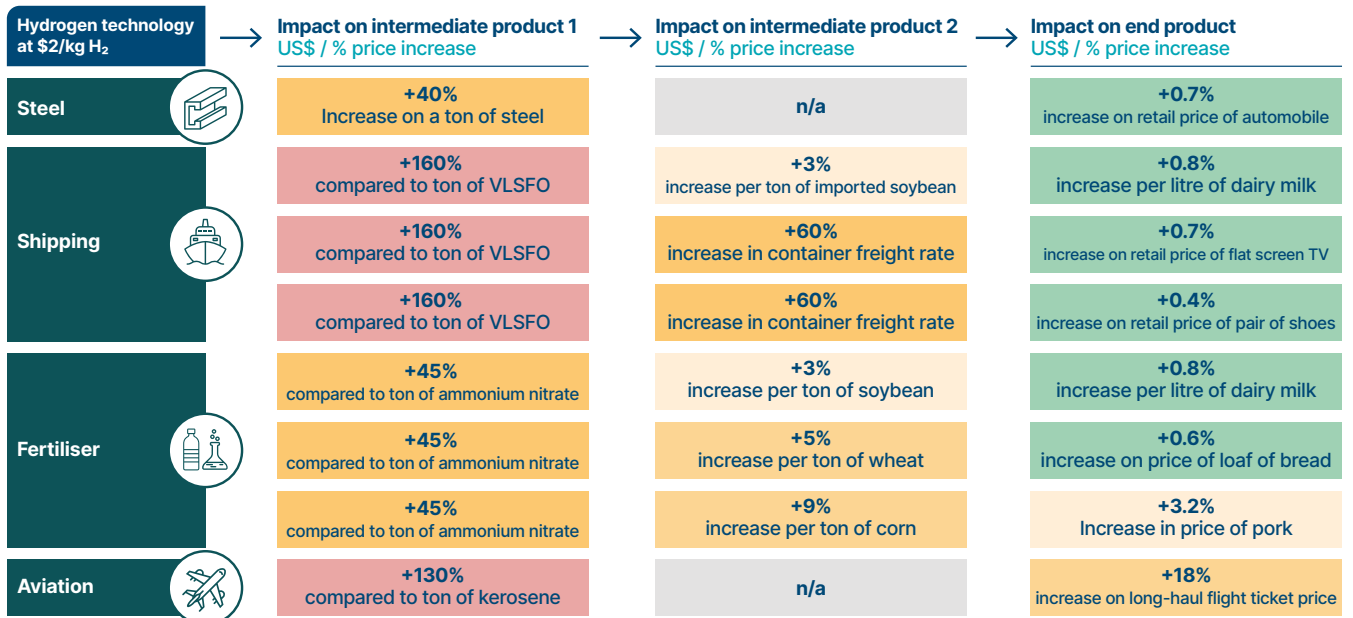

NOTE: Calculated for 2 \$/kg delivered hydrogen cost.

SOURCE: SYSTEMIQ analysis for the Energy Transitions Commission (2021)

Exhibit 1.16

## Even at \$1/kg further support will be required to make clean hydrogen use competitive in end-use applications

Carbon prices required for hydrogen to compete with the cheapest fossil fuel in each use-case (2050)  
\$/ton CO<sub>2eq</sub>

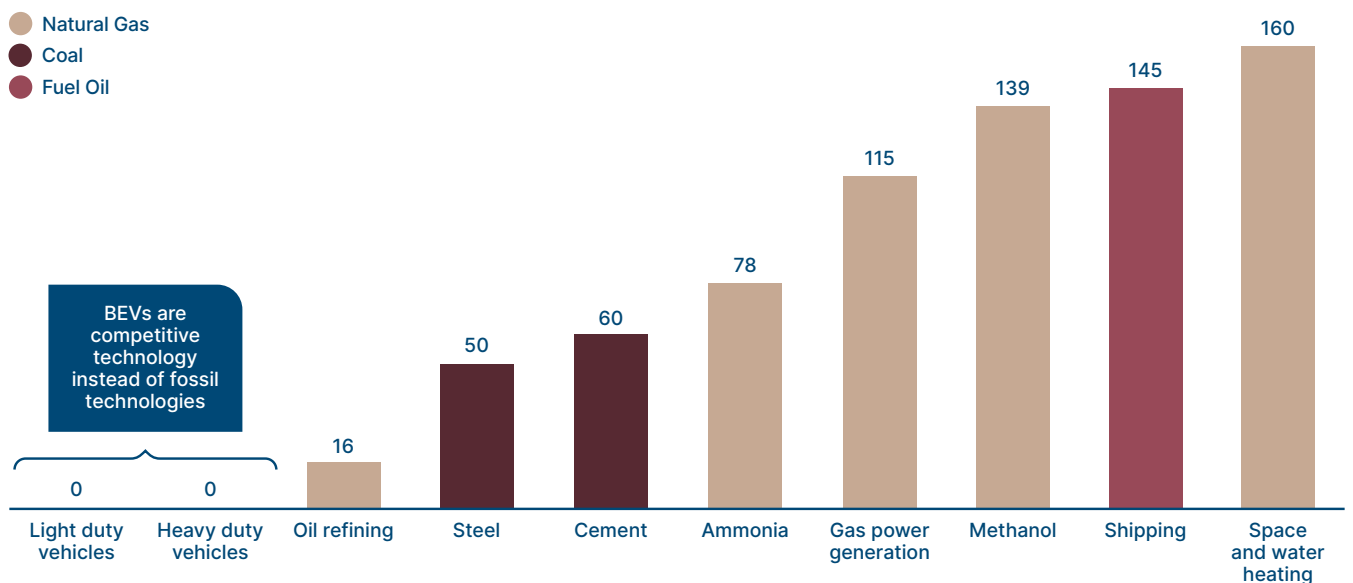

SOURCE: BloombergNEF (2020), *Hydrogen Economy Outlook*

Exhibit 1.17

and decarbonising shipping will have an even smaller impact on the cost of imported goods.<sup>67</sup> Exceptions are aviation, where end-consumers directly buy aviation services, and where decarbonisation using synthetic fuel (or biofuel) could add 10 to 20% to aviation ticket prices, as well as the chemical sector.<sup>68</sup>

Even where the “green consumer premium” is very low, higher costs at the intermediate product or service level will mean that demand for zero-carbon hydrogen will not develop without strong policy support at intermediate product level and pass through of costs to end consumers. In turn, without strong demand growth, potential production cost reductions will not be achieved. Chapters 2 and 3 discuss the policies and industry actions required to overcome this “chicken and egg” problem.

67 The end-consumer may be willing to pay higher price-premiums for green products in the market, making the extra cost for green hydrogen easier to manage at intermediary product level.

68 The chemical sector may also be an exception. However, there are many thousands of products in the chemicals sector and the cost premium would strongly depend on the specific value chain.



### III. Transport, storage and international trade of hydrogen

The vast majority of hydrogen used today is captive – i.e., produced and used on the same site for industries such as ammonia production and petroleum refining.<sup>69</sup> As a result, while some hydrogen is transported in either compressed gas or liquid forms, the total scale of transportation and storage is very small.<sup>70</sup>

The conversion, transport, and storage of hydrogen will entail additional costs which are greatest when hydrogen is used in smaller-scale distributed applications. Therefore, large-scale, co-located, captive hydrogen production and storage will in many cases offer the lowest clean hydrogen costs for end users. In particular, green hydrogen can be scaled relatively easily and enables flexible co-location and extension in proximity to the hydrogen end use.

While much hydrogen use will remain captive, developing the use of hydrogen across multiple sectors will require a far more extensive transport and storage system. In some cases, constraints around the availability of favourable resources (i.e., low-cost renewable electricity or natural gas) and hydrogen storage sites will require separating production and end use. The potential to transport hydrogen from favourable production sites (i.e., low-cost zero-carbon electricity or natural gas) to end use locations will be determined by the cost-differential relative to local production and other local constraints such as lack of available land area.<sup>71</sup> It may therefore be preferred in some circumstances to produce hydrogen in low-cost locations and transport it to higher cost ones.

However, differences in renewable electricity costs or physical availability between regions could also be balanced via transmission of electrons in high-capacity long-distance HVDC lines. If cheap gas continues to be used for hydrogen production, it might be cheaper to transport the gas and produce blue hydrogen closer to customers, rather than to transport hydrogen, if CCS storage is available.

Large-scale international energy trade in mid-century will therefore take a variety of forms reflecting local circumstances and future technology and cost developments. This section will in turn address:

- Hydrogen transport options and costs;
- Alternatives to hydrogen transport (power transmission and natural gas pipelines);
- Hydrogen storage;
- All-in cost comparison of different options;
- Implications for international trade in 2050.

## Hydrogen transport options and costs

Hydrogen can be transported in pure form as compressed gas at pressures up to 1000 bar or in liquid form at -253°C. Alternatively, it can be moved in the form of hydrogen vectors such as ammonia or liquid organic hydrogen carriers (LOHCs): the former is already extensively transported; the latter is at a lower TRL, and will need to develop further before becoming commercially applicable.

In each case, conversion requires significant energy input, with the total energy loss (as a percentage of the energy in the hydrogen) ranging from 0.5-11% for compression and decompression<sup>72</sup> to 73% if hydrogen is converted to ammonia and then back to hydrogen before use (Box A). Where ammonia is used in the end-application, however, the reconversion cost would not be incurred.

Which form of hydrogen is most economical to transport depends on the volumes and distances involved. Exhibit 1.18 identifies the likely least-cost solution and the cost per kilogram for different combinations. Three critical tipping points define the likely scope of use of different technologies:

69 The percentage of captive production differs by region and end-use sector, with an average of 95% estimated at the global level. Sources: IEA (2019), *The Future of Hydrogen*. Renewable Energy and Environmental Sustainability (2019), *The hydrogen economy and jobs of the future*.

70 There are currently only 6 salt caverns in use and less than 5000 km of hydrogen pipelines. Source: BloombergNEF, (2019), *Hydrogen – the economics of storage and delivery*.

71 These could include, but are not limited to: lack of CCS infrastructure, lack of land area available for variable renewable energy generation, demand/supply imbalance due to strong seasonal fluctuations.

72 Losses in geological storage much smaller (<2.5%). Source: BloombergNEF (2019), *Hydrogen – the economics of storage*.

# Three key volume / distance tipping points for moving hydrogen, making different modes and / or states competitive

Lowest cost form of hydrogen transportation<sup>1</sup> based on volume and distance  
\$/kg H<sub>2</sub>

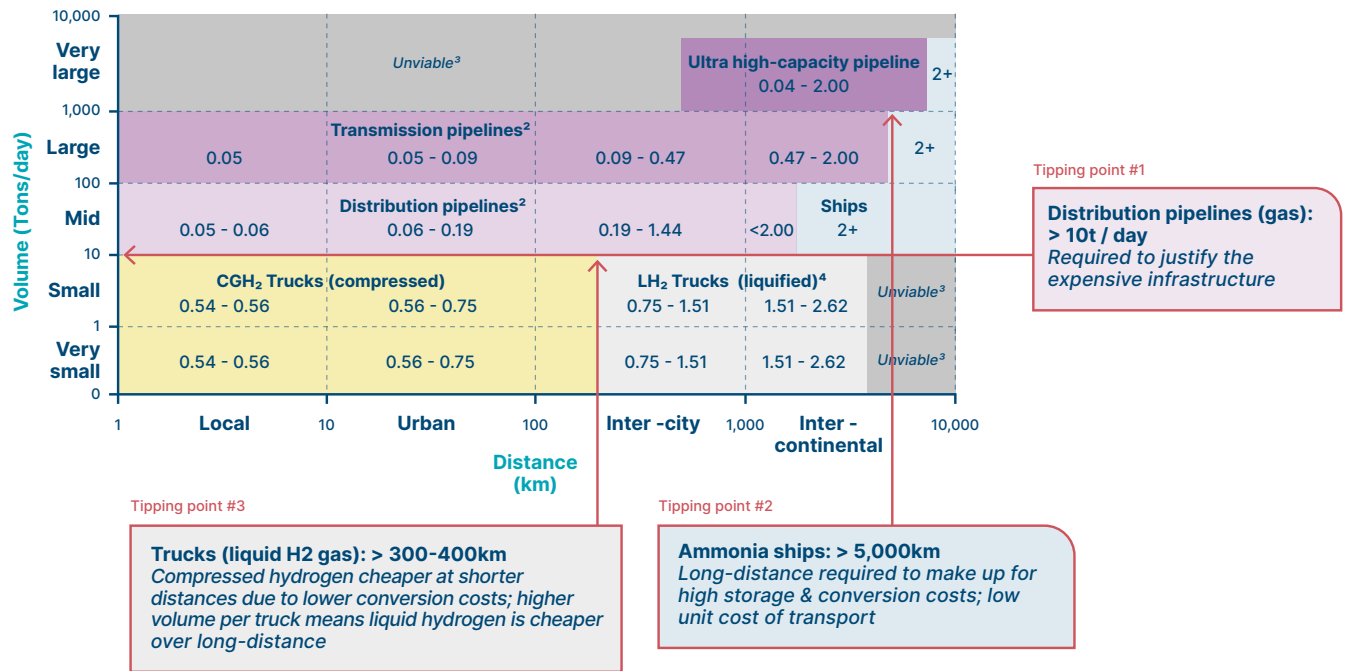

NOTE: <sup>1</sup> Including conversion and storage; <sup>2</sup> Assumes salt cavern storage for pipelines; <sup>3</sup> Ammonia assumed unsuitable at small scale due to its toxicity; <sup>4</sup> While LOHC (liquid organic hydrogen carrier) is cheaper than liquid hydrogen for long distance trucking, it is unlikely to be used as it is not commercially developed.

SOURCE: Adapted from BloombergNEF (2019), *Hydrogen: The Economics of Transport & Delivery*, Guidehouse (2020), *European Hydrogen backbone*

Exhibit 1.18

- Pipelines:** Once transportation volumes are above 10 tonnes per day (tipping point 1), pipelines are the lowest-cost transport option in most cases. Lower-capacity distribution pipelines with capacities below 100 tonnes per day will be preferred for local smaller networks (distances up to hundreds of kilometres), while transmission pipelines with a capacity beyond 100 tonnes per day will be the most economic means to carry large volumes over longer distances. Transmission pipeline costs could range from \$0.05/kg for a few kilometres, to \$0.5-3/kg for intercontinental distances (1000 km to 5000 km). However, as hydrogen use grows, ultra-high-capacity transmission lines<sup>73</sup> may be developed to transport up to 6000 tonnes per day, adding only \$0.07-0.23 per kg and 1000 km.<sup>74</sup> Today, there are only 4500 km of hydrogen pipelines in operation,<sup>75</sup> with the longest spanning 500 km, and most only a few kilometres. By contrast, there are 3 million km of natural gas pipelines.<sup>76</sup> Retrofitting existing high-capacity gas pipelines to enable hydrogen transportation is likely to cost ca. 40 to 65% of new pipeline construction, with the range dependent on the precise materials used in the initial pipeline.<sup>77</sup>
- Shipping:** Ships carrying ammonia are likely to be more economic for intercontinental distances of thousands of kilometres (tipping point 2) requiring high capacities (>100 t/day). Shipping hydrogen as ammonia for end use as ammonia could also be economical at shorter distances, as with current international seaborne ammonia trade. This avoids high-cost reconversion to hydrogen at destination, in effect shifting the ammonia production location (Exhibit 1.19).<sup>78</sup>
- Trucking liquid hydrogen gas:** For smaller volumes and distances (less than 10 tonnes per day and less than about 200 km – tipping point 3), trucks carrying compressed hydrogen are likely to be most competitive, but with costs now significant – e.g., \$0.5-2/kg dependent on distance covered. Liquid hydrogen trucks are likely to be cost-effective for smaller volumes over longer distances (hundreds of kilometres), but with costs rising in line with greater distance travelled.<sup>79</sup> These transport costs must be minimised to reach low-cost hydrogen for the small-scale end user (e.g., refuelling stations for use in long-distance trucking).

73 These are 48-inch capacity pipelines compared to 12-inch for transmission and 5-inch for distribution pipes. These ultra-high-capacity pipelines only exist for natural gas today. Sources: Guidehouse (2020), *European Hydrogen Backbone*; BloombergNEF (2019), *Hydrogen – the economics of transport & delivery*.

74 Guidehouse (2020), *European hydrogen backbone*.

75 Total of distribution and transmission pipelines.

76 IEA (2019), *The Future of Hydrogen*.

77 Guidehouse (2020), *European Hydrogen Backbone*.

78 Liquid hydrogen carriers are currently under development but are likely going to remain higher cost than ammonia. Source: BloombergNEF (2019), *Hydrogen – the economics of storage*.

79 Liquefaction facility requires a minimum scale to be cost-effective (>10s tonnes/day).

# Pipeline transport of hydrogen cheaper than shipping, in particular when end-use is hydrogen (high reconversion costs), but local green production often competitive

All-in delivered cost of hydrogen including production, transport and storage, 2050  
\$/kg H<sub>2</sub>

See technical Annex for further information

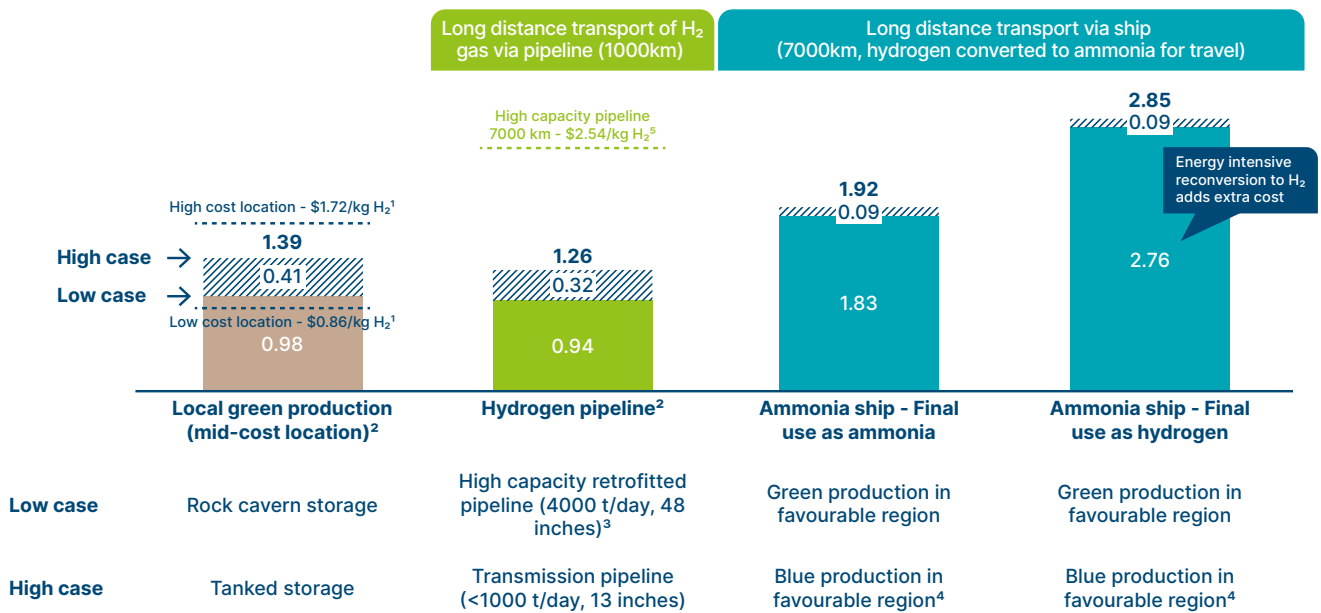

NOTE: <sup>1</sup> Green hydrogen production + low-cost rock cavern storage; <sup>2</sup> Green hydrogen production takes storage costs of 50% annual demand into account. <sup>3</sup> Lowest cost retrofitted natural gas pipeline according to European Hydrogen backbone report. <sup>4</sup> Blue hydrogen production via ATR + CCS (90%+ capture rate). <sup>5</sup> Assuming medium levelized cost of greenfield high-capacity pipeline according to European Hydrogen backbone report.

SOURCE: BloombergNEF (2019), Hydrogen – The Economics of Transport & Delivery, Guidehouse (2020), European Hydrogen backbone. Industry interviews.

Exhibit 1.19

## Alternatives to hydrogen transport

Instead of transporting hydrogen or its derived fuel ammonia, one may instead also consider transporting electricity and natural gas directly from low-cost locations before transforming them to hydrogen where it would be used.

### Moving electrons or hydrogen molecules

Locations with abundant cheap renewable resources could supply low-cost zero-carbon electricity via HVDC transmission lines. Where these pass over land, the costs vary greatly in line with population density, land costs, and degree of local opposition to development, and increase dramatically if undergrounding is required.<sup>80</sup> Undersea cabling may offer an alternative solution where feasible.<sup>81</sup> A number of major HVDC projects are currently under consideration, connecting for instance Australia and Singapore, Morocco and the UK (see ETC clean electrification report for details<sup>82</sup>).

HVDC costs decrease more significantly over longer distances than hydrogen pipelines which require compressor stations in regular intervals. In addition, the significant increases in variable renewables and electrification will likely see further cost declines of HVDC transmission lines while pipelines are considered a more mature technology with less cost reduction potential. Assessment of the relative economics of high-capacity electricity transmission and hydrogen transport therefore suggests that (Exhibit 1.20, further discussion in the annex):<sup>83</sup>

80 Similar considerations are relevant for greenfield hydrogen pipelines while less so for retrofitted infrastructure.

81 Offshore wind electrolysis is a special case where the transfer of electrons and hydrogen complement and compete with each other. Different configurations of placing the electrolyser on the offshore wind platform or onshore are being developed. Source: BloombergNEF (2021), *Hydrogen from offshore wind*.

82 ETC (2021), *Making Clean Electrification Possible: 30 years to electrify the global economy*

83 Further considerations between HVDC and hydrogen pipelines include 1) HVDC enables grid balancing, 2) Hydrogen pipelines and their pipeline volume & pressure serve as energy storage medium. 3) Undersea, overground, underground installation and right of passage or land acquisition costs can vary significantly depending on location. 4) If it is geographically unfeasible to build pipelines or HVDC, ammonia shipping will be the preferred option.

- If the energy is to be used as electricity in the destination country, transmission as electricity will always be preferred from a cost and energy efficiency perspective to converting to hydrogen, transporting as hydrogen, and converting back to electricity.<sup>84</sup>
- If low-cost hydrogen storage (see below for further details) is available close to the production site, but is not available close to the end use location, hydrogen pipelines are preferred.
- If low-cost hydrogen storage is feasible close to the end use location, the relative economics of HVDC and pipeline will decide the optimal solution:<sup>85</sup>
  - Where available, retrofitted natural gas transmission pipelines will offer the lowest transportation costs.
  - Low-cost high-capacity HVDC transmission lines (as seen in China today already)<sup>86</sup> are competitive compared to greenfield transmission pipelines from distances around 1000 km, becoming cheaper relative to new-build pipelines as distances increases (i.e. ca. 2% cheaper at 1000km, and ca. 18% cheaper at 3000km).<sup>87</sup>
  - Higher-cost high-capacity HVDC transmissions lines (as currently proposed in Europe and USA) are currently higher cost than new build pipelines, however, the gap between the HVDC and pipeline costs also decreases with distance. Over the coming decades HVDC transmission costs across all geographies are expected to see some decline due to learning effects from increased transmission grid build-out, as discussed in the parallel ETC clean electrification report.<sup>88</sup>

## Moving methane or hydrogen

If cheap gas availability continues to enable cost-effective blue hydrogen production, assessment of the transport economics suggests that (Exhibit 1.21):

- Where pipeline links to end markets are possible (and particularly if they already exist), it will prove more economic to transport gas for blue hydrogen production in the destination country rather than to transport hydrogen if CO<sub>2</sub> storage at the destination is feasible.
- Where pipelines are not available, liquefaction and transport of LNG would add prohibitive costs in most cases, as would liquefaction and shipping of hydrogen and ammonia (unless the end use of energy is in the form of ammonia) (see Exhibit 1.19), which might limit energy trade opportunities in any case.

Blue hydrogen production will therefore tend, in the long run, to be limited to cheap gas supply locations or locations where natural gas import via pipeline connections is feasible, where CO<sub>2</sub> storage is possible locally, and where there is a large local demand for hydrogen (or ammonia).

84 This assumes access of either pipelines or HVDC.

85 Note that HVDC would have to transmit the energy losses occurred during electrolysis. Pipelines generally offer slightly higher utilisation factors compared to HVDC due to their variable working pressures, in addition to offering a level of storage within the pipeline which can be valuable to smooth flows.

86 High capacity (c. 8GW) and long distance (e.g. 2000 km+ distances) HVDC transmission lines are primarily found in China today where they connect renewable resources in the North West with demand centres in the South West. Reported Chinese transmission lines cost (ca. \$5/(MWh\*1000km)) are lower than those reported in Europe (ca. \$10/(MWh\*1000km)) due to the higher capacity and longer length of Chinese lines, economics of scale due to scale of transmission line building, in addition to shorter permitting processes, lower land acquisition costs and lower installation costs. Source: Expert interviews and BloombergNEF (2016), *Global HVDC and interconnector database and overview*.

87 HVDC costs decline as distances increase as the majority of project costs are due to high-cost transformer stations at start/end of HVDC lines, and the impact of these large fixed costs is diluted with increasing distance. In contrast, hydrogen pipelines require the addition of compressor stations every 100-600 km, therefore costs per km do not significantly decrease beyond 1000 km distances. This assessment is based on current high-capacity, long-distance HVDC transmission line costs with some uncertainty around future cost developments of both HVDC and ultra-high-capacity hydrogen pipelines. HVDC costs, in particular, are expected to decrease across all geographies due to learning effects from increased transmission grid build-out as discussed in the parallel ETC clean electrification report. Sources: Guidehouse (2020), *European Hydrogen Backbone*; ETC (2021), *Making Clean Electrification Possible: 30 years to electrify the global economy*.

88 Energy Transitions Commission (2021), *Making Clean Electrification Possible: 30 years to electrify the global economy*.



# Over longer distances, transport of electrons from areas of favourable renewables via high capacity HVDC cables is increasingly competitive with new hydrogen pipelines

All-in delivered cost of hydrogen including production, transport and storage, 2050  
\$/kg H<sub>2</sub>

See technical Annex for further information

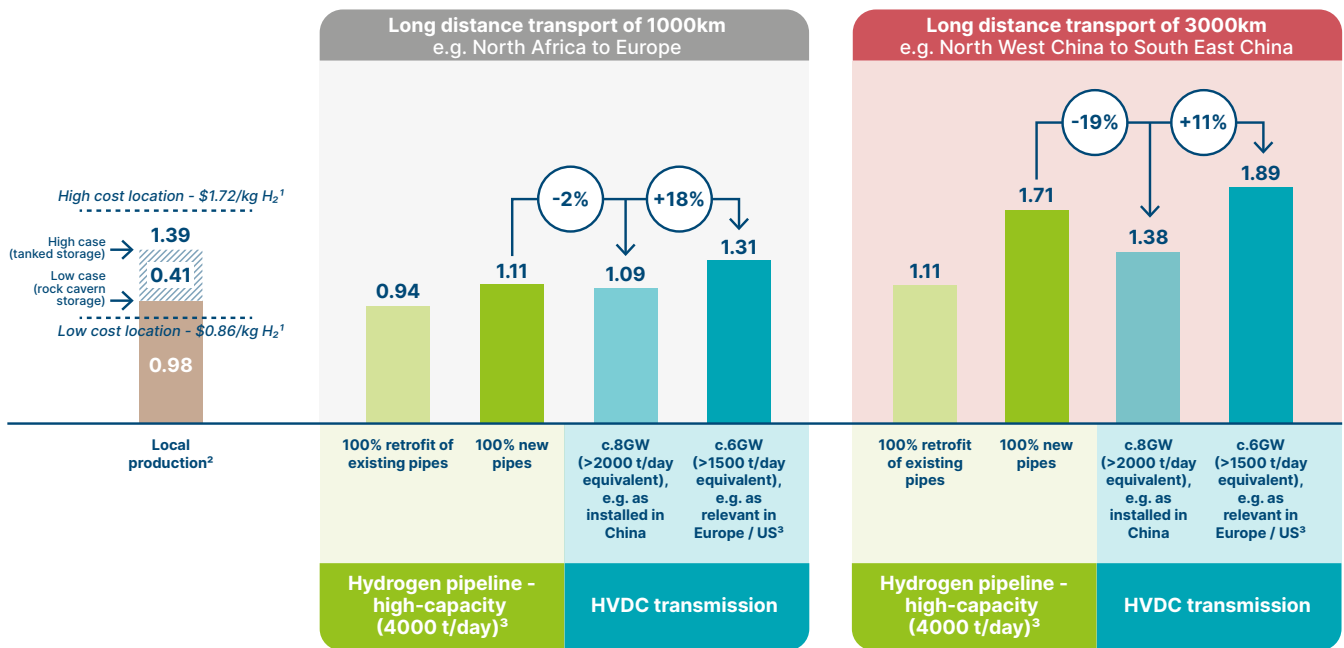

NOTES: <sup>1</sup> Green hydrogen production + low-cost rock cavern storage. LCOE \$13/MWh (mid), \$10/MWh (low), \$29/MWh (high). CAPEX: \$140/kW; <sup>2</sup> Green hydrogen production takes storage costs of 50% annual demand into account. <sup>3</sup> Capacity utilization factor for pipelines: 57% and 50% for HVDC.

SOURCES: BloombergNEF (2019), *Hydrogen: The Economics of Transport & Delivery*; BloombergNEF (2016), *Global HVDC and interconnector database and overview*; Guidehouse (2020), *European Hydrogen backbone*. Industry interviews

Exhibit 1.20

# Transport of very low cost natural gas via existing natural gas pipelines may enable cost-effective 'local' blue hydrogen production in some regions in 2050

All-in delivered cost of hydrogen including production, transport and storage, 2050  
\$/kg H<sub>2</sub>

See technical Annex for further information

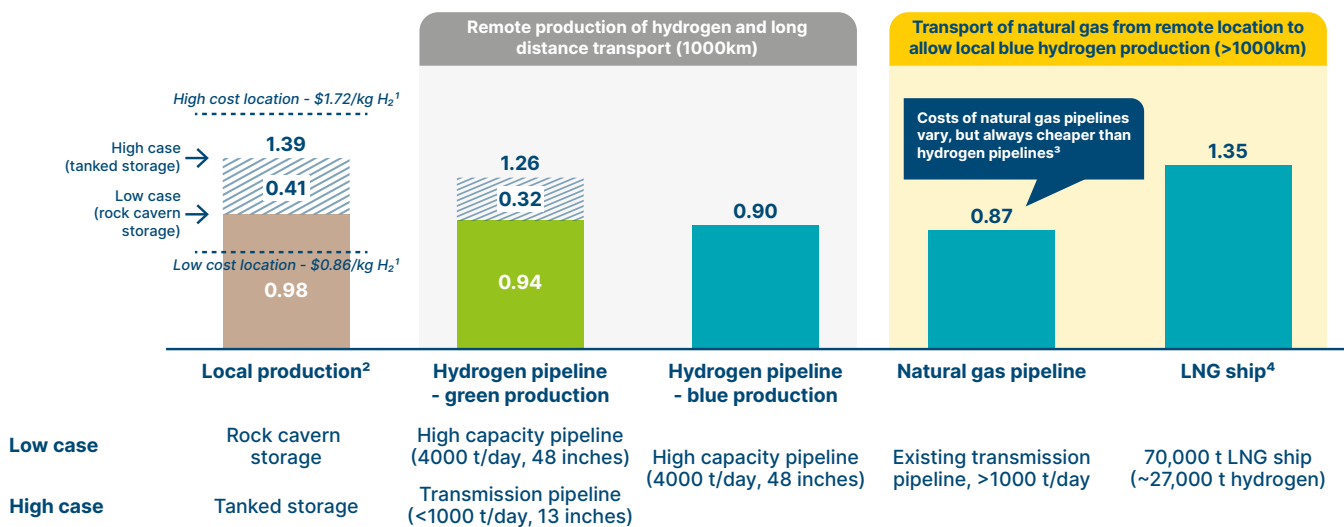

NOTE: Lowest cost blue hydrogen production cost: ATR + CCS (90%+ capture rate) with natural gas price of \$1/MMBtu. No hydrogen storage cost assumed for blue hydrogen. <sup>1</sup> Green generation + low-cost rock cavern storage. LCOE \$13/MWh (mid), \$10/MWh (low), \$29/MWh (high), CAPEX: \$140/kW; <sup>2</sup> Green hydrogen production takes storage costs of 50% annual demand into account. <sup>3</sup> Natural gas pipelines are cheaper to build and operate than hydrogen pipelines due to higher leakage of hydrogen, higher compression costs and slightly larger pipelines. <sup>4</sup> Assumes minimum cost of \$3/MMBtu for LNG liquefaction and transport

SOURCE: BloombergNEF (2019), *Hydrogen: The Economics of Transport & Delivery*, Guidehouse (2020), *European Hydrogen backbone*. Oxford Institute for Energy Studies (2019), *Outlook for Competitive LNG supply*

Exhibit 1.21

## Storage options and costs

A hydrogen economy on the scale envisioned in Section 1 will require very significant storage capacity. While most current captive uses of hydrogen require minimal storage (as steady output of grey hydrogen production facilities match the steady inputs required for most industrial processes), many future uses of hydrogen (or of hydrogen derivatives) will create storage needs, in particular:

- Hydrogen's potential role within power systems is explicitly as an energy storage medium, with hydrogen produced when variable renewable supply exceeds demand, and used when it is deficient.<sup>89</sup>
- Any use of hydrogen or its derived fuels as a transport fuel will require the development of significant new storage and refuelling facilities, e.g., in the road transport sector, as well as in ports and airports.
- Many industrial processes – e.g., Haber-Bosch synthesis of ammonia or direct reduction of steel – will require buffer stocks of hydrogen to allow continuous operation in the face of varying green hydrogen production. In this case, blue production would have the advantage of a steady production profile and therefore would not require hydrogen storage.
- Any use of hydrogen in residential heating will require buffer stocks of hydrogen, mirroring today's buffer stocks of natural gas.

In total, while the global natural gas system currently operates with storage capacity equal to about 12% of annual demand, BloombergNEF estimates that storage capacity equal to 15 to 20% of annual hydrogen use will need to be available.<sup>90</sup>

With hydrogen's natural state volumetric density only 30% of methane,<sup>91</sup> this implies either very large-scale storage needs or the application of compression technologies. The total volume of storage needed can be reduced by storing hydrogen in compressed gas or liquid form (or potentially in the future as LOHCs<sup>92</sup>). But the total unit capacity of these storage forms will make them uneconomic for applications where large storage is required (Exhibit 1.22). Large-scale geological storage will therefore have to play a major role in the hydrogen economy. This could be in one of three forms:

- **Salt caverns**, which can support the volumes and storage cycles required by large-scale industrial processes such as steel production, and which could provide storage at costs as low as \$0.1/kg by 2050 for storing and releasing 1 kg of hydrogen with a cycle time of 1 month.<sup>93</sup> However, there are significant differences in the availability of salt formations by region and salt caverns will not be available in all regions. As a result, the optimal location of some major industrial processes may change when they switch from fossil fuels feedstocks to hydrogen (Box D).
- **Rock caverns**, which are currently used to store LNG and petroleum products, but where further development is needed to assess the costs and feasibility of their use for hydrogen.
- **Depleted gas and oil fields**, which could in principle provide massive storage capacity but where technologies are still unproven, and the impact of contaminating impurities will limit feasible use in some sectors (e.g., fuel cell applications), in the absence of additional purification.

In the absence of any of the above, costly compressed storage in tanks or transport infrastructure (to enable supply of hydrogen from elsewhere) will be required. Irrespective of region and local availability of low-cost geological hydrogen storage, future storage needs will be a challenge: 5% of potential mid-century demand would require 4,000 large salt caverns, compared with only ca. 100 in use today for natural gas.

89 In addition, electrolyzers may offer flexible demand that can help to balance fluctuations in the power system.

90 BloombergNEF (2019), *Hydrogen – The Economics of Storage*.

91 BloombergNEF (2019), *Hydrogen – The Economics of Storage*.

92 Liquid organic hydrogen carriers.

93 The cycle time (i.e., the time period over which the cavern is on average filled ('charged') and then emptied of hydrogen) has a significant influence on the levelised cost of storage, but is limited by how fast one can withdraw hydrogen from the storage site. One month is considered the fastest for geological salt formations.

# Large-scale geological hydrogen storage is cheapest, although costs for small-scale storage (e.g. tanks) expected to decline significantly

	Storage option	Capacity <sup>1</sup> (t H <sub>2</sub> )	Cost of storage (\$/kg)	TRL	Example applications
Gaseous state	Salt caverns	300 – 10,000	0.23 (2019), 0.11 (Future)	9	Large volume storage, medium term (weeks-months)
	Rock caverns	300 – 2,500	0.71 (2019), 0.23 (Future)	2 – 3	Large volume storage, medium term (weeks-months)
	Depleted gas fields	300 – 100,000	1.90 (2019), 1.07 (Future)	2 – 3	Large volume storage, long term (seasonal)
	Pressurized containers	0.005 – 1.1	0.19 (2019), 0.17 (Future)	9	Pipelines, short-distance trucking
Liquid state	Liquid hydrogen	0.0002 – 0.2	4.57 (2019), 0.95 (Future)	7 – 9	Long-distance trucking
	Ammonia	0.001 – 10,000	2.83 (2019), 0.87 (Future)	9	Long-distance shipping
	LOHCs	0.0002 – 4,500	4.50 (2019), 2.86 (Future)	7 – 9	Long-distance shipping
Solid state	Metal hydrides	0.0001 – 0.002	Not evaluated	7 – 9	Trucking

Storage type: Geological / Tanks

Forecast period: 2019 / Future (c. 2050)

NOTES: <sup>1</sup> Capacity is "per unit" – ie. one salt cavern. Costs of hydrogen storage depends significantly on cycle rate (ie. how often the gas is filled and withdrawn). Geological storage of hydrogen is limited in how fast gas can be withdrawn (ca. 1 month for salt cavern).

Exhibit 1.22

## Availability of large-scale storage differs by region, those without salt caverns access (e.g. China, India) will have to rely on costly or unproven tech

Current number of geological storage sites for natural gas and hydrogen (2018)

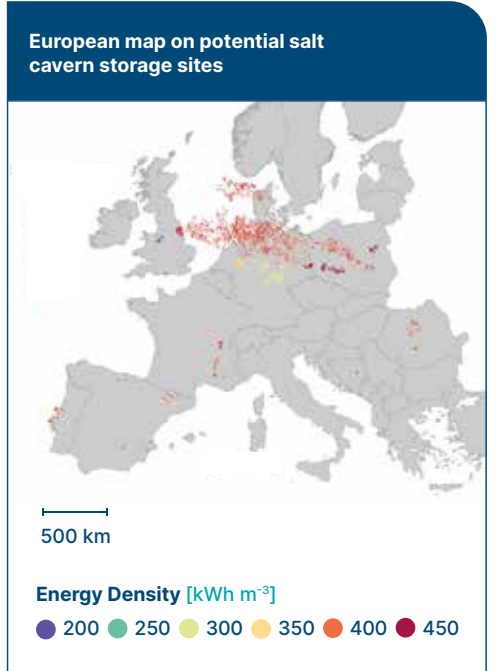
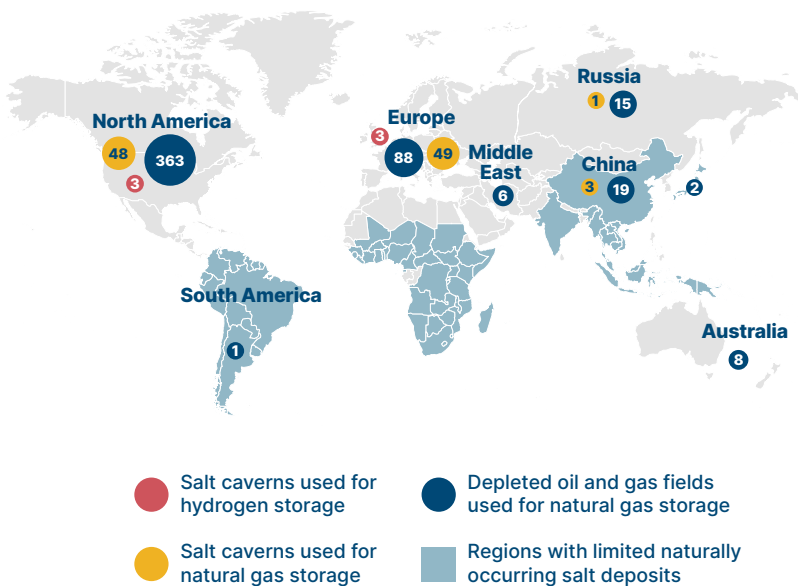

Box D

SOURCES: BloombergNEF (2019), *Hydrogen – The economics of storage*; Preprints (2019), *Technical Potential of Salt Caverns for Hydrogen Storage in Europe*



## All-in costs, including conversion, transport and storage

Total cost of delivered hydrogen is the essential metric for hydrogen off-takers and will vary significantly according to specific circumstances. Hydrogen use in small-scale distributed applications (e.g., refuelling stations) will cost significantly more than in large-scale industrial process cases. Large-scale production close to the off-taker will offer the least-cost option, for instance (Exhibit 1.23):

- If large-scale hydrogen production with co-located use costs \$1.63/kg, short-distance pipeline-based transportation for 50 km to use that same hydrogen in a different activity within the same geographical cluster would only increase the cost to \$1.72/kg.<sup>94</sup>
- By contrast, pressurising and transporting it by truck to a more remote location (e.g., a hydrogen refuelling station) could increase the cost to \$2.78/kg.
- Estimated costs would be even higher (\$3.42/kg) if small-scale electrolyzers were used on a distributed basis to cater for remote uses, and higher still (over \$5/kg) if those small electrolyzers used grid-based electricity rather than dedicated renewables.

These additional distribution costs increase the likelihood that hydrogen's role will lie primarily in large-scale applications (e.g., steel, ammonia plants).

### Distributed, onsite production of hydrogen at small-scale users more expensive than offsite production and transport; but large scale, co-located production cheapest

"All-in" cost of delivered hydrogen including production, transport and storage, 2030  
LCOH, \$/kg

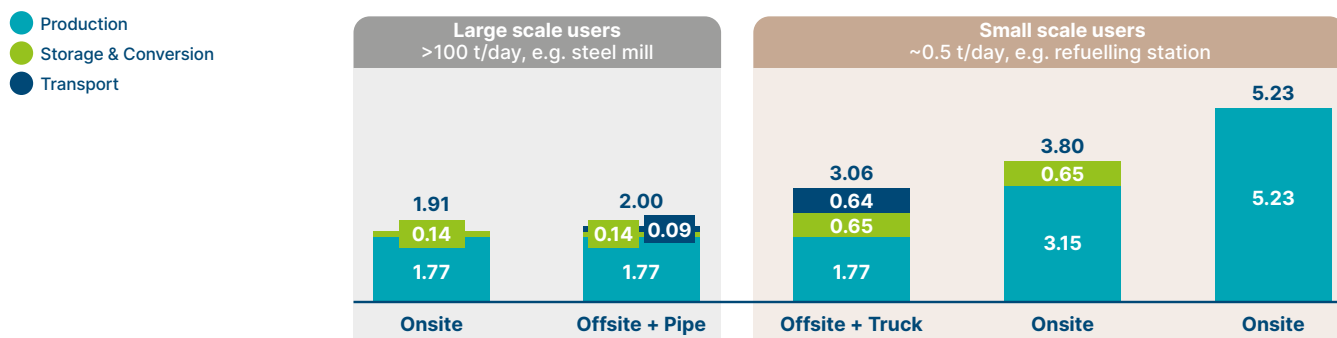

Category	Parameter	Unit	Large scale (PV)		Large scale (PV)	Small scale (PV)	Continuous grid
			1	2	3	4	5
Production	Electricity source		PV (large-scale)	PV (large-scale)	PV (large-scale)	PV (small-scale)	Continuous grid
	Electricity cost <sup>1</sup>	\$/MWh	24	24	24	40	100
Storage	Electrolyser CAPEX <sup>2</sup>	\$/kW	290	290	290	580	580
	Mode <sup>3</sup>		Rock cavern	Rock cavern	Pressurised tank	Pressurised tank	N/a
Transport	Mode <sup>4</sup>		N/a	Pipe (13cm)	Truck	N/a	N/a
	Distance	km	N/a	50	200	N/a	N/a

**NOTES:** <sup>1</sup> Electricity cost estimated higher for small scale user with onsite production due to smaller VRE plant size. <sup>2</sup> Electrolyser CAPEX for large scale (20 MW) alkaline electrolyser according to conservative scenario in Exhibit 1.10. Electrolyser CAPEX ca. 2x for 1 MW size according to IRENA. Similarly, higher costs would be expected for PEM electrolyser with smaller foot-print due to space constraints. <sup>3</sup> Small scale users would likely use small scale pressurized tank storage. No storage assumed for grid connected electrolysis, as hydrogen could be produced "on-demand". <sup>4</sup> Pipe would require 10-100 t/day to justify the infrastructure. A large refuelling station today has a capacity of less than 1 t/day and would therefore not qualify for a distribution pipeline in most cases.

**SOURCES:** BloombergNEF (2020), *Hydrogen – the economics of storage*; IRENA (2020), *Green hydrogen cost reduction*

<sup>94</sup> Co-location of large-scale production and use may be limited in some cases due to space availability.

## International trade in 2050 – opportunities and choices: hydrogen, natural gas or electrons

Green hydrogen production costs depend crucially on the cost of zero-carbon electricity, which currently differs considerably across regions. Renewable electricity costs currently vary from below \$20/MWh in most favourable locations with abundant land, sun or wind (e.g., North-Africa, Spain, Australia, Chile) to over \$100/MWh in countries such as Japan.<sup>95</sup> As a result, if large hydrogen demand already existed, it could be economic to produce clean hydrogen in cheap locations and transport it to high-cost locations even if more expensive ship transport was required (Exhibit 1.19). As laid out above, in certain circumstances, HVDC and natural gas may also be competitive energy vectors.

By mid-century, large-scale international energy trade is likely to take a variety of forms reflecting local circumstances and future technology and cost developments. The development of clean hydrogen as a tradable commodity may offer other additional advantages such as creating buffer stocks and hedging against potential shortages.

Future reductions in renewable electricity costs across all locations will, however, result in reduced differentials between low- and high-cost regions, while transport costs are unlikely to fall by an equivalent amount.<sup>96</sup> This implies that, while the trade of hydrogen or its alternatives will play a role in a net-zero economy, long-term opportunities for profitable international trade in hydrogen will be significantly smaller than today's fossil fuel trade and may be limited to:

- Situations where cheap high-capacity pipeline transport (in particular retrofitted) is economic, typically up to distances of 1000 km;
- Trading ammonia for end use as ammonia (rather than for reconversion to hydrogen at the destination) in the shipping, chemical and fertiliser industries;<sup>97</sup>
- Shipping of ammonia or LNG (if CCS available at the destination) for hydrogen end use, only in locations that cannot be connected via HVDC or pipeline (hydrogen or natural gas);
- A few countries (like Japan) that may have an energy deficit which forces them to import energy even if costs are relatively high.

In addition, there may be significant trade in electricity (whether eventually converted to hydrogen or used directly) and natural gas via:

- High-capacity HVDC transmission, in particular for very long distances (thousands of kilometres);
- Transport of very-low-cost natural gas in existing pipelines to locations with CO<sub>2</sub> storage capability enabling blue hydrogen production.

It is also likely that the emergence of a hydrogen economy will also lead over time to changes in the optimal location of energy- and hydrogen-intensive industries, with for instance, steel production potentially locating close to sources of cheap renewable electricity (or very cheap natural gas)<sup>98</sup> and with clean steel internationally traded rather than the energy feedstock.

<sup>95</sup> The difference in cost for Japan is driven by resource and land use constraints, as well as inefficiencies in power market design.

<sup>96</sup> The price difference between high and low-cost regions could decline by ca. 40%.

<sup>97</sup> Use of 100% ammonia in power plants may be economic in some locations with energy deficit.

<sup>98</sup> The location of iron ore also plays a crucial role in choosing the production location.



An aerial photograph of a port area with several large industrial structures, possibly cranes or shipyard equipment, extending into the water. A large green circular overlay is centered on the image, containing the text 'Chapter 2' in white. The background shows a blue sea and a clear sky.

## Chapter 2

# Scale-up challenges, required actions and investments



It is clear from Chapter 1 that hydrogen can and must play a major role in the future zero-carbon economy, alongside massive clean electrification. While there have been false starts before, the following factors now make it highly likely that the recent surge in clean hydrogen will materialise:

- Falling prices and increased VRE capacity enable low-cost green hydrogen production;
- Increasing public awareness of climate change and national decarbonisation commitments drive the search for zero-carbon solutions;
- Net-zero targets and legislation increase the focus on harder-to-abate sectors where direct electrification is not always possible, and which often require hydrogen;<sup>99</sup>
- Significant green recovery funds following the Covid-19 epidemic are dedicated to the acceleration of clean hydrogen.

The challenge is to develop clean hydrogen production and use fast enough to first unlock low-cost production and then put the sector on a growth trajectory to make full decarbonisation by 2050 feasible. This will require:

- Achieving sufficient scale early enough to drive down green hydrogen production costs by ensuring that announced projects materialise within the next decade;
- Ensuring rapid enough demand development to make a path to full decarbonisation by 2050 credible – which will require explicit policies to accelerate the application of clean hydrogen in some key sectors;
- Ensuring that key enabling investments are in place – for green hydrogen, the most important is massive development of the electricity system; while for blue, support for CCS infrastructure development will be required;
- Using the development of specific hydrogen clusters to drive integrated development of production, end use, transport and storage to scale up the clean hydrogen value chain coherently;
- Strategic planning of the national and international transport and storage needs which will be required in the 2030s and 2040s;
- Establishing appropriate safety and quality standards, social acceptance as well as clean hydrogen certification schemes.

This chapter describes in turn why each of these actions are required. It concludes by identifying the total investments required to develop a large-scale clean hydrogen economy.

<sup>99</sup> In previous “hydrogen-hypes”, a strong focus was put on light-duty road transport which failed to materialise due to high cost of hydrogen and FCEVs, lack of refuelling stations, and relatively low energy efficiency of hydrogen in road transport. Similarly, strong action on decarbonisation failed to materialise.

# I. Critical scale and pace of cost declines

As set out in Section 1.2, green hydrogen costs will very likely undercut blue costs in most locations in the long term. But today green hydrogen typically costs around \$2.5-4.5/kg for large-scale projects and up to \$5/kg for small projects, versus costs of \$1.3-2.6/kg and \$0.7-2.2/kg for blue and grey, respectively.<sup>100</sup> These high costs reflect the use of expensive electricity and the small scale of green hydrogen projects which results in high capital costs for electrolyzers.

Should green hydrogen developments that have already been announced by governments and corporates materialise, this would likely be sufficient to drive green production costs in average locations below \$2/kg in the 2020s, making it competitive with blue in average locations and in some locations with grey. Most favourable locations for green hydrogen production (where renewable energy costs could reach ca. \$10/MWh in the 2020s) may be cheaper than blue hydrogen even in low-cost regions (see Exhibit 2.4), although storage costs for intermittent green production could add ca. \$0.12/kg - \$0.35/kg of hydrogen produced.<sup>101</sup> Delivery of existing plans is not assured, though, and will require acceleration of demand for clean hydrogen, as will be discussed in further detail in Chapter 3.

The cost of green hydrogen is driven by the capital cost of electrolyzers and the cost of low/zero-carbon electricity.<sup>102</sup> Both are falling rapidly and, in addition, low electrolyser costs themselves make it easier to access cheap electricity.<sup>103</sup>

## Recent ambitious company announcements, national commitments and cost reduction targets

### Project pipeline & industry targets

- Green pipeline: ~ **50 GW across all announced projects** (timelines not specified), ~ 3 GW capacity by 2023;
- Electrolyser **project size increased dramatically** (from <2MW 2015-2020 to ~70MW), but remain less than 1 GW
- **European Clean Hydrogen Alliance target: 80 GW** (2030)
- **Alliances** (Green Hydrogen Catapult) & consortia (HyDeal ambition) target green H<sub>2</sub> **prices below 2 \$/kg** in 5 years<sup>1</sup>

### Country targets & public support

- **Over 30 countries** released **hydrogen roadmaps**, with 13 full national hydrogen strategies
- **Concrete GW installation targets** (c. 2030) dominated by European players
- **International momentum growing** with many more national hydrogen strategies in development

#### Project examples:



**BP & Ørsted:** 50 MW electrolyser for H<sub>2</sub> production in BP refinery powered by offshore wind from Ørsted. (Germany)



**Iberdrola & Fertiberia:** 800 MW electrolysis by 2027 for ammonia production. 20 MW for co-feed operational in 2021. (Spain)



**Shell & Gasunie & Equinor & RWE:** Develop 4 GW of electrolyser powered by 10 GW offshore wind by 2030. (Netherlands)



**Australian consortium<sup>2</sup>:** Plan to develop 14 GW electrolyser with up to 26 GW wind and solar generation. Recently granted major project status.

#### European country green hydrogen commitments:



**EU:** 40 GW target by 2030 (6 GW in 2024), with national targets including:



**Germany:** 5 GW by 2030



**Poland:** 2 GW by 2030



**France:** 6.5 GW by 2030



**Italy:** 5 GW by 2030



**Spain:** 4 GW by 2030



**Portugal:** 2.1 GW by 2030



**Chile:** 25 GW target by 2030

**NOTES:** <sup>1</sup> Green hydrogen catapult targets <2 \$/kg production cost in 2026, HyDeal <1.5 €/kg including T&S by 2030 <sup>2</sup> InterContinental Energy, CWP Energy Asia, Vestas and Pathway Investments

**SOURCES:** IEA (2020), *Hydrogen Projects Database*; Hydrogen Council (2021), *Hydrogen Insights*; European Commission (2020), *European Clean Hydrogen Alliance fact sheet*; Green Hydrogen Catapult, "World's green hydrogen leaders unite to drive 50-fold scale-up in six years", December 8th 2020; HyDeal Ambition, "30 energy players initiate an integrated value chain to deliver green hydrogen across Europe at the price of fossil fuels", February 11th 2021; BP, "bp and Ørsted to create renewable hydrogen partnership in Germany", November 11th 2020; Iberdrola, "Iberdrola and Fertiberia launch the largest plant producing green hydrogen for industrial use in Europe", July 24th 2020; North2, "North2 welcomes new international partners RWE and Equinor", December 7th 2020; The Chemical Engineer, "Australian Government backs renewable energy hub", October 23rd 2020

Exhibit 2.1

<sup>100</sup> It should be noted that blue and grey projects are always medium to large scale (100s of MW minimum typically). Costs of small-scale blue projects would therefore be significantly larger.

<sup>101</sup> This includes locations with natural gas price >\$5-6/MMBtu such as large parts of Europe and China. Storage costs for intermittent green hydrogen production could add ca. \$0.12/kg (salt cavern) - \$0.35/kg (rock cavern) assuming 50% of the produced hydrogen would need to be stored at some point. Source: BloombergNEF (2019), *Hydrogen – the economics of storage*.

<sup>102</sup> Load hours and efficiency are two other relevant metrics.

<sup>103</sup> At low electrolyser CAPEX, the capacity utilisation factor becomes less relevant for the cost of hydrogen production. A small number of load hours at times of VRE oversupply (cheap electricity) becomes sufficient to produce low-cost hydrogen.

# Electrolyser costs

Electrolyser costs are predicted to fall drastically due to economies of scale and learning curve effects:

- If projects and national targets that have already been announced materialise, at least 60 GW of electrolysers will come online during 2020s (Exhibit 2.1).
- Learning rates and economies of scale associated with this capacity could deliver fully installed alkaline electrolyser costs declines from today's ca. \$850/kW to ca. \$230-380/kW by 2030.<sup>104</sup>

An analysis of current total costs in China, where manufacturers already report fully installed system prices below \$300/kW<sup>105</sup>, increase confidence that these dramatic cost reductions can be achieved. In addition, European manufacturers such as Nel have published plans to achieve system costs of \$300-400/kW within the next five years<sup>106</sup> (Box E, see further discussion in Annex).

In addition, the energy consumption to produce green hydrogen (i.e., the electrolyser efficiency) will significantly decrease in the next years from ca. 53 kWh/kg of hydrogen to ca. 45 kWh/kg of hydrogen, or potentially even lower with novel technological innovation.<sup>107</sup>

## Electrolysers – the heart of green hydrogen production

### Electrolyser cost breakdown

- Balance of plant is significant cost driver (ca. 50%) in a typical project
- Project and regional variation of soft costs, construction & mobilisation, and balance of plants costs
- All cost elements anticipated to decline with increasing electrolyser deployment. Split of cost drivers expected to remain approximately constant.

### Cost breakdown of 20MW alkaline electrolyser installation<sup>1</sup>

% of total installed costs

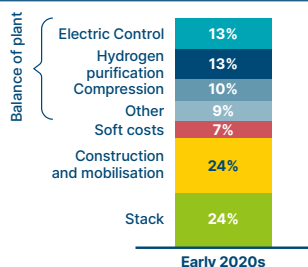

### Increase in project size drives cost reduction

- Increasing order size drives growth in module size leading to lower costs - leading manufacturers are already increasing module size to 20 MW (from <5 MW)
- All cost parameters (not only stack) decline with increasing module and project size

### Electrolyser cost decline with module size

\$/kW alkaline electrolyser

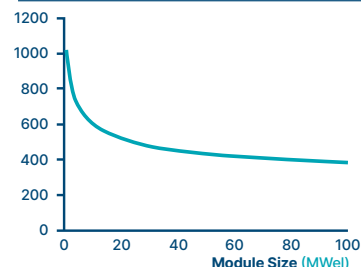

### Combination of falling zero-carbon electricity cost and increasing electrolyser deployment will enable low cost green hydrogen

### What is needed to get to below 2 €/kg green hydrogen (in Europe)

LCOH €/kg H<sub>2</sub> delivered

European scenario from Material Economics

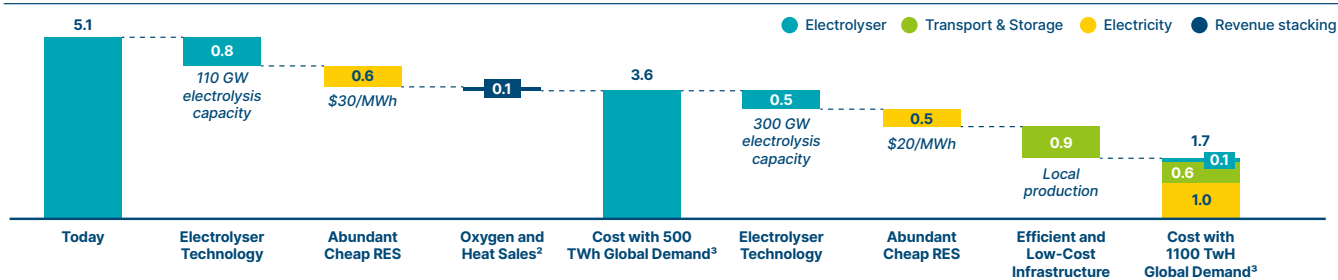

NOTES: <sup>1</sup> Total cost of project \$780/kW. 'Soft costs' include project design, management and overhead. <sup>2</sup> 40% of oxygen and 20% of heat sold. <sup>3</sup> 500 TWh corresponds to ca. 10 Mt and 1100 TWh represents ca. 22 Mt. Assumption: 50 kWh/kg energy consumption for electrolysers.

SOURCES: BloombergNEF (2021), 1H2021 Hydrogen Market Outlook; IRENA(2020), Green Hydrogen Cost Reduction; Material Economics (2020), Mainstreaming green Hydrogen in Europe; ThyssenKrupp (2019), Hydrogen From large-scale electrolysis

Box E

104 Today's costs of \$850/kW refer to fully installed cost (including project planning, contingency, etc.) based on expert interviews. BloombergNEF reports \$780/kW for a 20 MW alkaline electrolyser fully installed cost. Source: BloombergNEF (2021), 1H2021 Hydrogen Market Outlook. 2030 costs of \$230-380/kW estimated based on an installed capacity of 60 GW (starting capacity of 200 MW in 2019, \$1200/kW electrolyser cost) and learning rate of 13-18% based on Hydrogen Council, BloombergNEF and IRENA reports. For further comparison, see section 1.2.

105 BloombergNEF (2020), Hydrogen Economy Outlook

106 Hydrogen production plant excluding installation, civil works and building. Source: Nel (2021), Capital Markets Day.

107 BloombergNEF (2019), Hydrogen – Economics of production from renewables.

## Electricity prices – in part a function of electrolyser costs

The cost of renewable electricity has fallen by 70-90% in the last 10 years and will continue to fall over the next decade (see ETC clean electrification report<sup>108</sup>). But it is important to recognise that the relevant price of electricity for hydrogen electrolysis is also a function of electrolyser costs.

Electricity to drive electrolysis can be sourced from either or a combination of:

- The electricity grid at average electricity prices across the year to enable steady hydrogen production;<sup>109</sup>
- The electricity grid, but drawing on it only when lower off-peak prices apply, which is likely to happen for significant periods in electricity systems dominated by variable renewables,<sup>110</sup> with prices sometimes close to zero in some hours when renewable generation would otherwise be curtailed – grid-connected electrolysers could thus act as a key power system balancing technology by varying demand for power in response to supply (see ETC clean electrification report<sup>111</sup>);
- Dedicated renewables capacity, whether ‘virtually’ purchased via PPAs (Power Purchase Agreements) but delivered over shared grid infrastructure, or physically co-located as “captive renewables”<sup>112</sup>

In the latter “captive renewables” case, the use of dedicated renewables not only allows access to low renewable generation costs, but can also result in savings through the elimination of grid connection costs (Exhibit 2.2).<sup>113</sup> Batteries may in principle be used to smooth short-term fluctuations of renewables availability, but are too expensive to store significant amounts of energy to increase the electrolyser utilisation.<sup>114</sup>

### LCOEs from dedicated renewables can be up to 15% lower than grid connected generation due to savings in power electronics

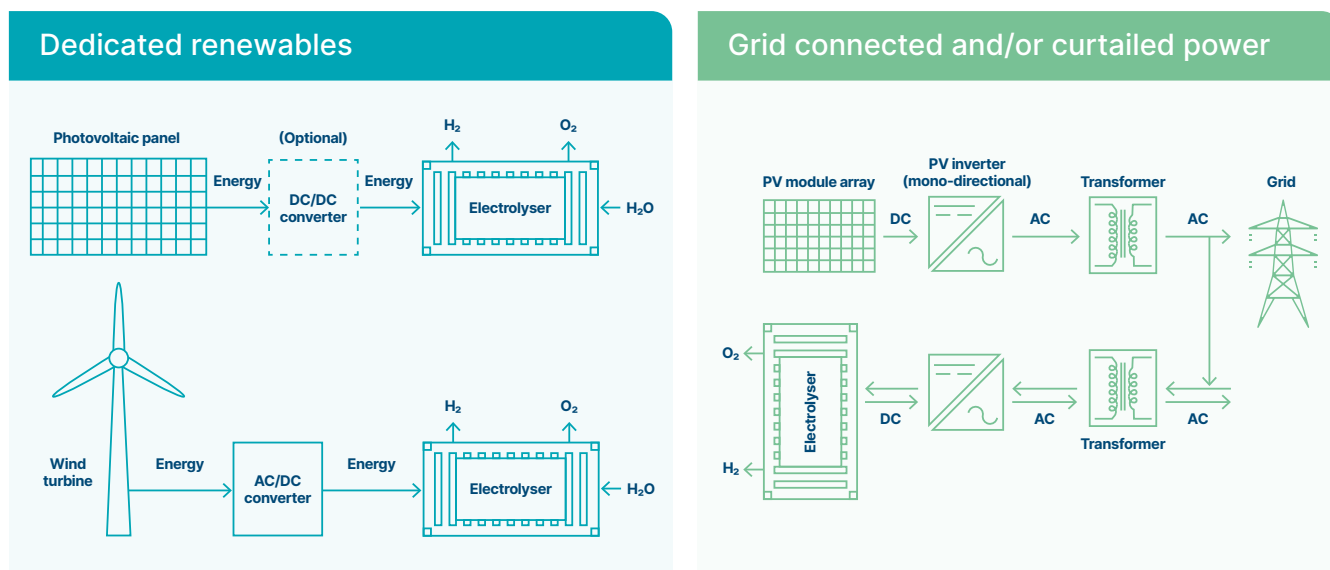

SOURCE: Adapted from BloombergNEF (2019), *Hydrogen – the economics of production from renewables*

Exhibit 2.2

108 ETC (2021), *Making Clean Electrification Possible: 30 years to electrify the global economy*.

109 We expect that, by 2030, the grid will in most geographies be dominated by dedicated renewables (see ETC clean electrification report).

110 The number of hours will depend on demand side response measures and local power system characteristics.

111 ETC (2021), *Making Clean Electrification Possible: 30 years to electrify the global economy*.

112 Captive renewables also reduce the pressure on the power system and transmission grid to balance VRE intermittency. Further option exists for captive renewables to retain grid connection to enable the sale of balancing services to the grid.

113 In addition, higher deployment of electrolysers would accelerate VRE build-out which accelerates learning effects and ultimately likely lowers renewable electricity LCOE.

114 In a lowest-cost system configuration, a cost trade-off exists between electrolyser capacity, hydrogen storage size and potential battery storage. Even with strongly falling battery prices, batteries are found to increase the total system costs. Source: TERI (2020), *The potential of hydrogen in India*.



In the past, high electrolyser costs have made it important to run electrolysers at high capacity in order to reduce capital costs per unit of production, which implied reliance on more expensive electricity from the grid. But as electrolysers capital costs fall drastically, high utilisation will no longer be crucial. As Exhibit 2.3 shows, once electrolyser costs fall below \$300/kW, electricity cost becomes the almost sole driver of green production costs as long as utilisation rates are above around 2000 hours per annum.

Low electrolyser costs will therefore make possible for green hydrogen production to use low-cost electricity from either:

- Very low-cost dedicated renewables, in a context in which LCOE for wind and solar are likely to fall below \$20/MWh in more favourable locations;<sup>115</sup>
- Relatively low-cost renewables which generate for a higher proportion of time enabling greater electrolyser utilisation (such as offshore wind or combining solar and wind generation), with production costs also subsidised via electricity sold to the grid when prices are high.<sup>116</sup>

Green hydrogen production costs could be further subsidised through 'revenue stacking' from complementary services, e.g., sale of oxygen biproduct for oxy-combustion or the sale of balancing services to power networks.<sup>117</sup>

## Above ca. 2000 hours annual electrolyser utilisation electricity cost is key determinant of green hydrogen cost; dedicated renewables likely to be best source of zero-carbon power

Green hydrogen production costs  
\$/kg

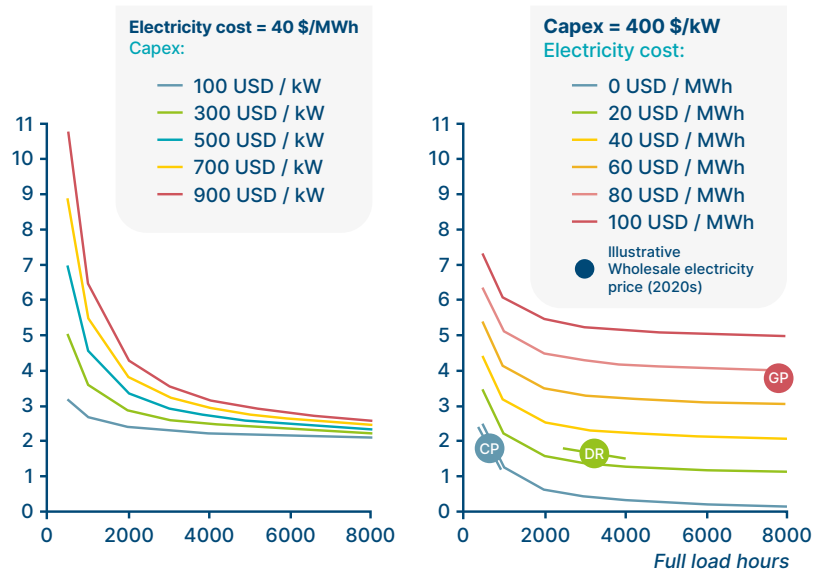

Electricity sources for green hydrogen production – commentary

- DR** **Dedicated renewables:** reasonable load hours (> 2k) and competitive electricity cost (below \$20/MWh in future), likely H<sub>2</sub> market price for will be set by H<sub>2</sub> price when produced with dedicate renewables
- CP** **Curtailed power volumes will develop if electrolyser CapEx declines considerably** (e.g., to \$200/kW)  
Increased variable renewables results in higher number of hours with cheap power (curtailment)
- GP** **Given higher average electricity price, grid power would likely not be used**  
Load hour advantage (100%), but minimal costs benefits above ~2k hours

Note, in a renewables dominated power system (as discussed in the ETC's clean electrification report) curtailed power and grid power will start to overlap and merge, with electrolysers able to support grid balancing by offering flexible demand at times of over-supply

NOTES: Electricity consumption 48 kWh/kg, Electrolyser lifetime = 25 years, Discount rate = 8%

SOURCE: SYSTEMIQ analysis for the Energy Transitions Commission (2020) based on IEA (2019), *The Future of Hydrogen*

Exhibit 2.3

115 ETC (2021), *Making Clean Electrification Possible: 30 years to electrify the global economy*.

116 Higher capacity factor VREs enable oversizing of the VRE generation compared to the electrolyser size which effectively increases the hours at which the electrolyser operates at full capacity. Costs can be optimised by sizing the VRE generation capacity, electrolyser capacity and hydrogen storage according to local production profiles of VRE and costs of respective components. In addition, further revenues can be generated through selling to the grid when grid prices are high (e.g., when off-shore wind is producing, but solar not producing).

117 Grid connected electrolysers can provide grid balancing services in particular in locations with a weak electricity grid. The demand-response time for PEM electrolysers can be on the seconds timescale and is already used for grid-balancing services in Denmark. Sale of oxygen and heat as by-products may offer additional revenue of \$0.1/kg of hydrogen. Oxy-combustion uses pure oxygen instead of air during the combustion process and may be used in e.g. cement industry to increase the concentration of CO<sub>2</sub> and lower the cost of CCS. Sources: HyBalance, "HyBalance pioneering facility proves Power-to-Hydrogen to be a viable way to balance the grid and transfer renewables into industry and mobility", November 30<sup>th</sup> 2020; ; AirProducts (2011), *Oxygen economics published in International cement review*; Material Economics (2020), *Mainstreaming green hydrogen in Europe*

Given these prospective cost trends, already announced plans for the development of green hydrogen could produce costs below \$2/kg and in some cases possibly below \$1.50/kg in the 2020s (Exhibit 2.4).<sup>118</sup> The production cost challenge can therefore be overcome provided existing policy targets are met and announced investment projects implemented. For this to happen, critical policy support mechanisms will be required, including critically policies to overcome the use case cost-premium described in Chapter 1 and therefore ensure sufficient demand for clean hydrogen off-take in the 2020s. Necessary policy support mechanisms are described in more detail in Chapter 3.

## C. 50 GW electrolyser capacity would unlock green hydrogen production costs of \$2/kg or less in 'average' locations, making it competitive with blue & even some grey

Green hydrogen production costs<sup>1</sup> (excluding storage costs<sup>2</sup>, 2020s)  
\$/kg

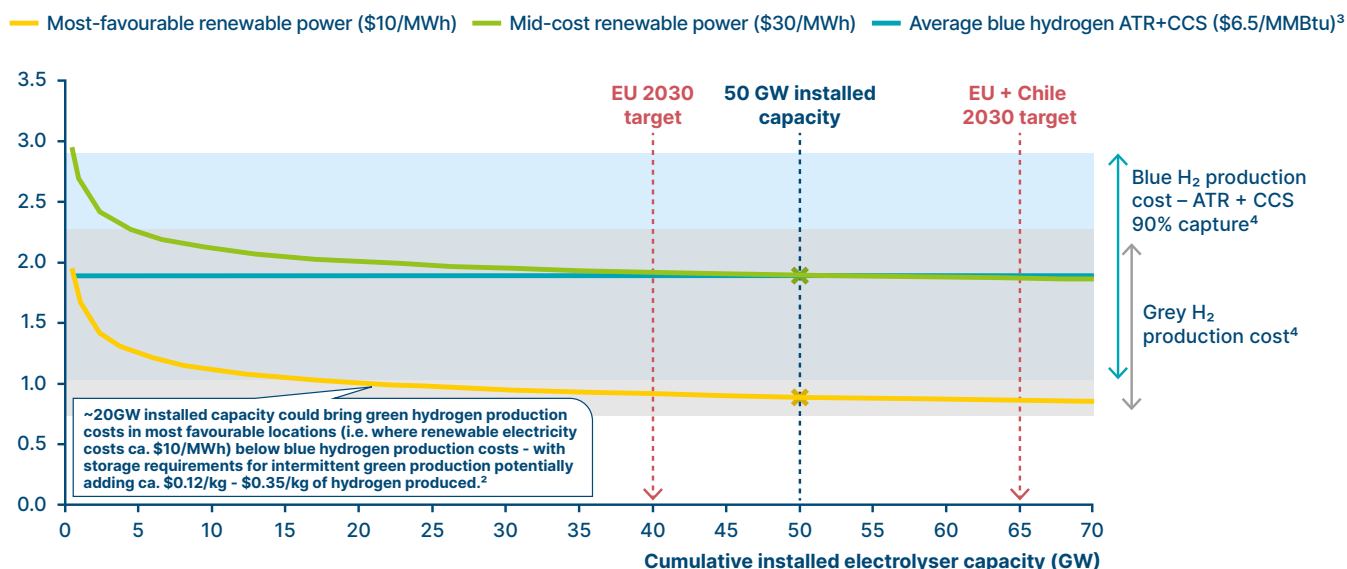

Exhibit 2.4

NOTES: <sup>1</sup> Assumptions for green hydrogen production: i) LCOE mid-cost: \$30/MWh, LCOE most favourable: \$10/MWh (assuming dedicated renewable power generation), ii) Electrolyser CAPEX cost decline calculated based on a 18% learning rate, iii) Starting capacity in 2020: 200 MW, iv) CAPEX in 2020: \$1200/kW; <sup>2</sup> Storage costs for intermittent green hydrogen production could add ca. \$0.12/kg (salt cavern) - \$0.35/kg (rock cavern) assuming 50% of the produced hydrogen would need to be stored at some point; <sup>3</sup> Blue line represents ATR+CCS (90% CO<sub>2</sub> capture) at \$6.5/MMBtu natural gas price illustrated as an approximate global average natural gas price such as seen in parts of Europe, India and China. <sup>4</sup> Band refers to gas prices: \$1.1-10.3/MMBtu.

SOURCES: BloombergNEF (2019), *Hydrogen – the economics of production from fossil fuels*, *Hydrogen – the economics of production from renewables* and *Hydrogen – the economics of storage*

118 Early deployment will focus on geographic locations with high utilisation factors (asynchronous wind and solar resources) to overcome initially higher electrolyser costs.



## II. Feasible paths to 2050 – the need to accelerate demand growth

Even if green hydrogen costs fall dramatically in the 2020s, and if blue hydrogen costs also fall, the scale of hydrogen production and use required by 2050 would be difficult to achieve if production capacity scale-up happens late, requiring a massive and abrupt step change in electrolyser and VRE generation build-up rates in the 2040s. Public policy should therefore support faster growth in the 2020s – reaching volumes greater than those required solely to drive reduction in green hydrogen production cost – to scale the value chain in a way that makes 2050 targets achievable.

### Credible scale-up pathways to 2050 targets

Over the next 30 years, clean hydrogen production capacity per annum will depend on the number of installed blue and green hydrogen projects, which in turn depend on the scale of the production value chain (e.g., electrolyser manufacturing capacity for green, CCS infrastructure for blue). However, there are limits to how far green or blue hydrogen capacity increases can simply respond to any given pattern of demand growth while still remaining attractive profitable business.

Thus, taking the example of green hydrogen production: (Exhibit 2.5)

- In a scenario in which production capacity would grow linearly with fixed yearly capacity increases to reach annual production of 800 Mt by 2050, the large production capacity of electrolysers built in the 2040s would become obsolete in the 2050s, as replacement rates will not be sufficient to occupy production capacity. Multiple electrolyser manufacturing assets would require financing in the late 2040s, but investment would be unlikely to flow in the absence of longer-term market.
- A more credible development path would see a faster ramp-up of production in the 2020s and early 2030s, followed by a stabilisation of the scale of the electrolyser market. Annual clean hydrogen build-up rates would grow more rapidly in the 2020s, plateauing from the mid-2030s onwards at a level of ca. 35 Mt per annum. This would require a significant growth in demand in the early ramp-up period, to sustain earlier value chain development.

### A feasible production ramp-up requires earlier and more stable capacity increases – with 35 Mt/year production added by mid 2030s

Annual new clean hydrogen capacity addition to reach 800 Mt by 2050

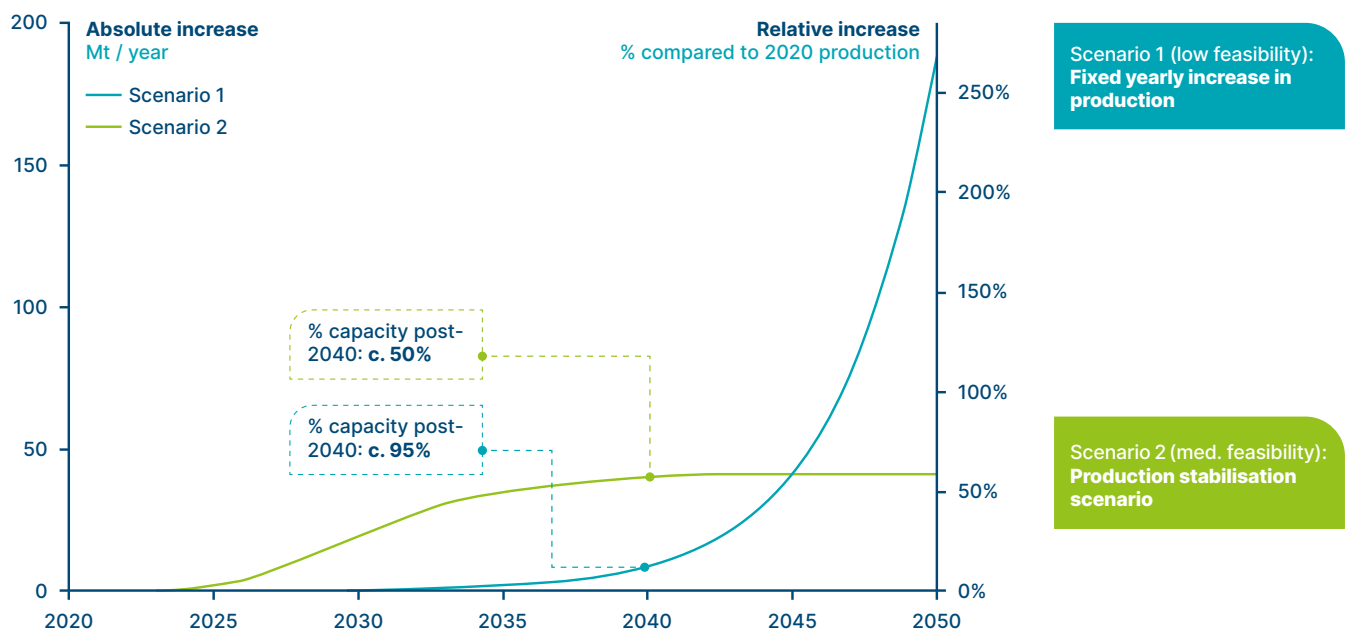

NOTE: Scenario 1 curve assumes constant year-on-year growth of 35%. Scenario 2 uses S-Curve logistic equation.

SOURCE: SYSTEMIQ analysis for the ETC

Exhibit 2.5



Hydrogen demand levels required in the 2020s to underpin a feasible ramp-up trajectory for both green and blue hydrogen production would be considerably higher than those required simply to drive cost reductions in green hydrogen. A significant acceleration of CCS infrastructure development for blue hydrogen and renewables for green hydrogen would also be required.

## Driving early demand

Early growth in demand for clean hydrogen will be critical to accelerate projects in the 2020s, making rapid cost declines possible and setting clean hydrogen on a feasible scale-up trajectory to meet its role in a mid-century net-zero economy. However, as described in Section 1.2, using hydrogen in many end use applications will still represent a “green cost premium”, even when clean hydrogen prices reach \$2/kg or below. Public policy support will therefore be required to pull forward clean hydrogen demand. The specific policies needed to achieve this are described in detail in Chapter 3, but the key objectives should be to:

- Drive rapid decarbonisation of all existing hydrogen production (in particular in oil refining and ammonia production, see Annex for detailed discussion of fertilisers);
- Accelerate rapid technology development and sufficient early adoption of hydrogen in other key sectors with lower technology-readiness but large potential demand, like steel production and ammonia in shipping, to make rapid take-off in the 2030s feasible.

The possible sequencing of growth by sector will reflect a balance of different factors, including technological readiness, sector-specific pressure to decarbonise, economics versus alternatives, and the extent to which applications depend on the development of new distribution networks. Exhibit 2.6 illustrates a possible sequencing over time with:

- Existing applications of grey hydrogen in fertilisers and refining creating immediate potential demand for clean hydrogen (60%+ of expected demand by 2030) – with fertiliser demand likely to grow over time, but refining demand eventually declining as oil use diminishes;

### Potential sequencing of demand sector “take off” over next 3 decades

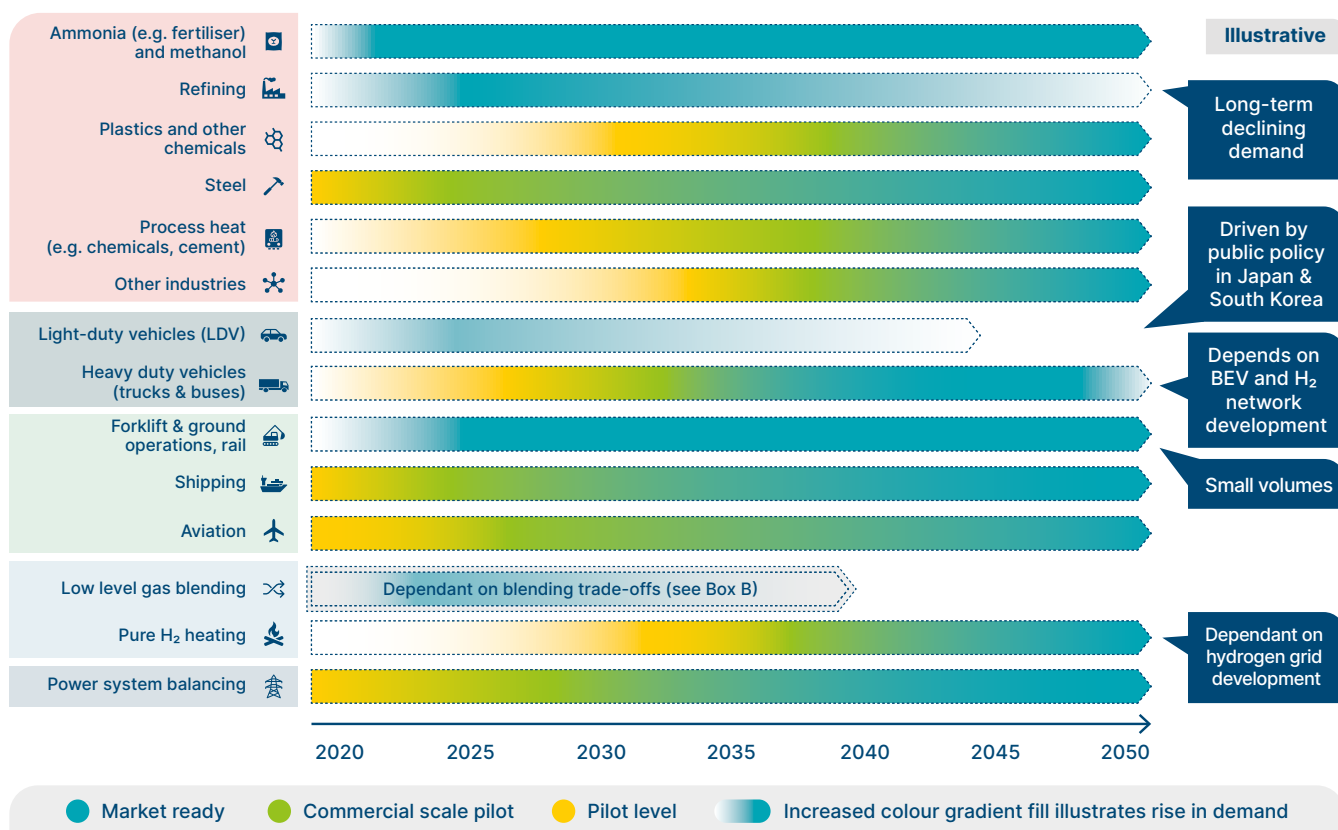

Exhibit 2.6

SOURCE: SYSTEMIQ analysis for the Energy Transitions Commission (2021)

- Heavy-duty road, rail and captive transport applications (e.g., fork lifts and drayage) creating potential early sources of demand, but with the eventual scale depending on the uncertain future balance between battery and hydrogen based long distance, heavy-duty trucking, and with FCEV use dependent on the development of hydrogen distribution and refuelling systems;
- Steel and long-distance shipping creating significant potential demand from 2030 onwards, but with pilot plants and initial commercial-scale investments in the 2020s;
- Sectors such as plastics and other petrochemicals potentially contributing significant growth in the 2040s.

A detailed assessment of use cases to identify potentially early off-takers is included in Annex.

The specific sectoral sequencing should reflect national circumstances and will depend on policy actions. Precise predictions of the resulting global balance of hydrogen demands are therefore impossible. Exhibit 2.7 sets out an illustrative, plausible set of sectoral hydrogen use trajectories which would see clean hydrogen demand reach 43 Mt by 2030 (further details in Annex). Such a pathway would prepare the way for the massive take-off of green hydrogen production and use in 2030s illustrated in Exhibit 2.8.



# Illustrative scenario assessing potential demand acceleration in 2020s reaches ca. 45 Mt clean hydrogen demand in 2030 & requires mobilisation across 5 key sectors

Illustrative scenario

Illustrative demand scenario for clean hydrogen in 2030  
Mt / year, 2030

- New demand
- Old demand
- Light duty vehicle
- Other industries
- Forklift and ground operations
- Power flexibility
- Bus
- Building heating<sup>1</sup>
- Rail
- Aviation
- Iron and Steel
- Heavy duty vehicle
- Shipping
- Refining<sup>2</sup>
- Ammonia

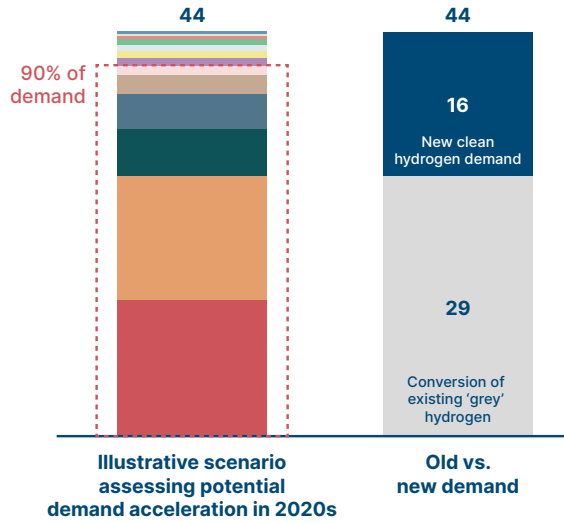

Sectors with most rapid demand acceleration

- **Ammonia:** ca. 50% of ammonia production switches to clean hydrogen<sup>3</sup>
- **Refining:** ~1/3 of dedicated grey hydrogen production facilities in refineries transition to clean hydrogen
- **Shipping:** 5 % of total shipping demand decarbonised<sup>4</sup> (corresponds to ~900 small container ships)
- **HDV:** 10% new heavy duty trucks from 2027 are FCEV
- **Steel:** 15-20 plants using 100% hydrogen-DRI (32 Mt/year green steel)

Exhibit 2.7

NOTES: <sup>1</sup> Illustrates use of hydrogen in residential and commercial building heating. The dominant form of this in the 2020s is likely gas grid blending. <sup>2</sup> Clean hydrogen demand in the refining category summarises existing uses in desulphurisation and in hydrocracking of crude oil. In addition, methanol production, heat provision in chemical industry and production of high value chemicals was also included in this category for this analysis. <sup>3</sup> Ammonia production for use in the chemical industry and ammonium and nitrate based fertiliser production can transition to clean hydrogen without significant retrofit. Urea production (50%+ of today's fertiliser production) is more challenging to convert to clean hydrogen. See appendix for more details. <sup>4</sup> This demand would correspond to ca. 900 small container ships.

SOURCE: SYSTEMIQ analysis for the Energy Transitions Commission (2021)

## Potential scale-up of the hydrogen economy

Hydrogen demand  
Mt Hydrogen / year

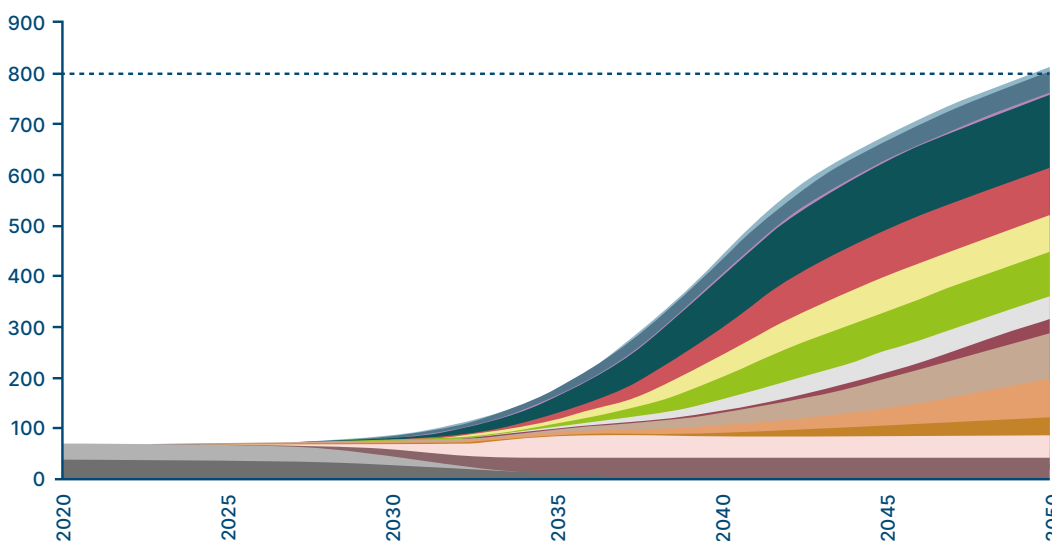

Illustrative scenario

### Clean hydrogen

- Light duty transport
- Heavy duty transport
- Rail
- Shipping
- Aviation
- Building heating
- Power flexibility
- Other industries
- Cement
- Iron and Steel
- Chemicals process energy
- High value chemicals
- Ammonia
- Methanol

### Fossil hydrogen

- Ammonia (grey)
- Refining (grey)

Exhibit 2.8

SOURCE: SYSTEMIQ analysis for Energy Transitions Commission (2021)

### III. Key actions to enable production ramp-up

There are no inherent barriers to ramping up clean hydrogen production in line with the demand growth illustrated in Exhibit 2.8, but it is important to anticipate the scale of investments required, and to identify and remove some barriers to the development of clean hydrogen production.

## Green hydrogen production growth

Natural resources are sufficient to support massive green hydrogen growth, but the development of the hydrogen value chain will require huge increases in zero-carbon electricity supply and anticipation of new supply chains:

- Minerals:** Analysis of future demands for key minerals required in alkaline electrolyser production suggest that there will be no long-term constraints.<sup>119</sup> If all 800 Mt per year of hydrogen were to be produced by electrolysers built using primary nickel, less than a third of known reserves would be required (see Exhibit 2.9).<sup>120</sup> The situation is different for the currently less-well established PEM electrolysers: IRENA suggests that current production of iridium and platinum would only support 3-7 GW annual production, thus alternative materials and reductions in material intensity will be essential for the PEM technology to scale.<sup>121</sup> Electrolyser recycling and 'designed-in' circularity can significantly reduce new minerals required.<sup>122</sup> However, it is important to anticipate the timing of mineral demand growth which will be driven both by hydrogen developments and by direct electrification<sup>123</sup> (as set out in the ETC clean electrification report<sup>124</sup>).

## Nickel demand will increase for use in alkaline electrolysis but sufficient reserves exist to meet this need

Nickel consumption and potential demand from alkaline electrolysers  
Million tons

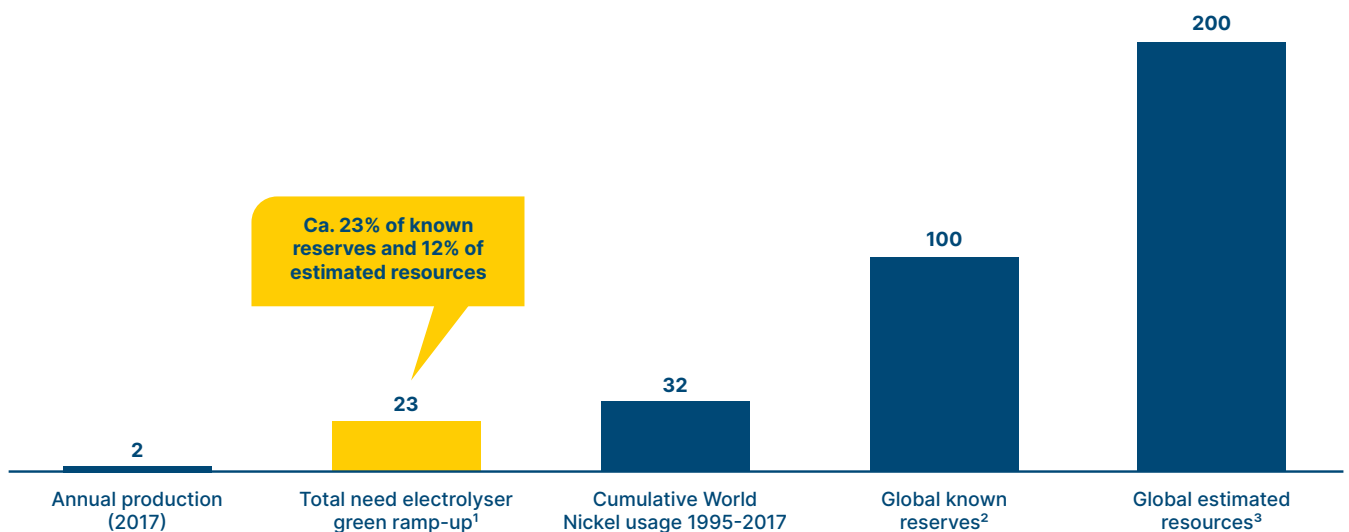

Exhibit 2.9

**NOTES:** <sup>1</sup> Based on 85% of 800 Mt hydrogen demand from green hydrogen (ca. 7300 GW). This assumes conservatively that the nickel consumption per MW for alkaline electrolysis will not reduce compared to today. More efficient material usage and improved recycling will likely lower the demand for primary Nickel for electrolyser manufacturing <sup>2</sup> Global known reserves describe already discovered mining sites that could be used for extracting Nickel. <sup>3</sup> Global estimated mineral resources indicate that further sites for Nickel mining likely exist that are currently not known.

**SOURCES:** International Nickel study group (2018), *The World Nickel Factbook 2018*; Energies (2017), *Site-Dependent Environmental Impacts of Industrial Hydrogen Production by Alkaline Water Electrolysis*

119 Electrolysers rely on specific metals to realise high efficiencies and long-term stability (today: Nickel for alkaline electrolysers, Platinum and Iridium for PEM electrolysers).  
120 Assuming unchanged nickel consumption in electrolyser in 2050. Sources: Energies (2017), *Site-Dependent Environmental Impacts of Industrial Hydrogen Production by Alkaline Water Electrolysis*

121 IRENA (2020), *Green Hydrogen Cost Reduction: Scaling up Electrolysers to Meet the 1.5°C Climate Goal*

122 Nickel is considered to have a high recyclability and has had an end-of-life recycling rate of 68% in 2010. (Source)

123 Nickel is also a key mineral for example in today's Li-Ion battery technology and significant demand increases are expected from this sector. Source: BHP (2020), *Climate Change Report*.

124 ETC (2021), *Making Clean Electrification Possible: 30 years to electrify the global economy*.

- **Water:** Although each kilogram of hydrogen produced requires significant water use (up to 15-20 kg, including for cooling<sup>125</sup>), the water requirements for 800 Mt hydrogen p.a. is much less than that needed for extraction and processing of fossil fuels today (Exhibit 2.10) and would only account for ca. 0.7% of global freshwater use globally.<sup>126</sup> Moreover, desalination can be deployed in water-scarce regions, adding less than \$0.02/kg hydrogen.<sup>127</sup>
- **Electricity:** It is important to recognise that green hydrogen production will add very significantly to the massive increases in electricity supply in any case required for direct electrification (Exhibit 2.11). If 85% of 800 Mt hydrogen per year was produced via electrolysis, this would require about 30,000 TWh<sup>128</sup> of zero-carbon electricity generation, in addition to the 90,000 TWh likely required in any case for direct electrification.<sup>129</sup> This massive ramp-up of zero-carbon generation (primarily from VRE) is feasible, but needs to be enabled by the supportive policies and anticipatory investments described in the ETC clean electrification report.<sup>130</sup> It is therefore essential that national and regional strategies for the growth of zero-carbon electricity generation and the supporting transmission and distribution networks anticipate these very large increases.
- **Supply chains development:** Scaling clean hydrogen production will require the development of extensive new supply chains for key materials and capabilities – for electrolysis and for VRE generation. These developments are physically feasible within the required timescale, but failure to anticipate in advance could result in bottlenecks, both locally and globally, which could slow progress and increase costs. In 2020, only 0.2 GW of electrolyzers were installed across the world: manufacturers have announced plans to increase their production capacity to at least 3.5 GW by the end of 2021;<sup>131</sup> however, by the late 2020s and 2030s, yearly additions will need to reach over 30 GW per year.

## Water availability is not a global limiting factor for the deployment of hydrogen production at scale

Water Consumption  
Billion tonnes per year

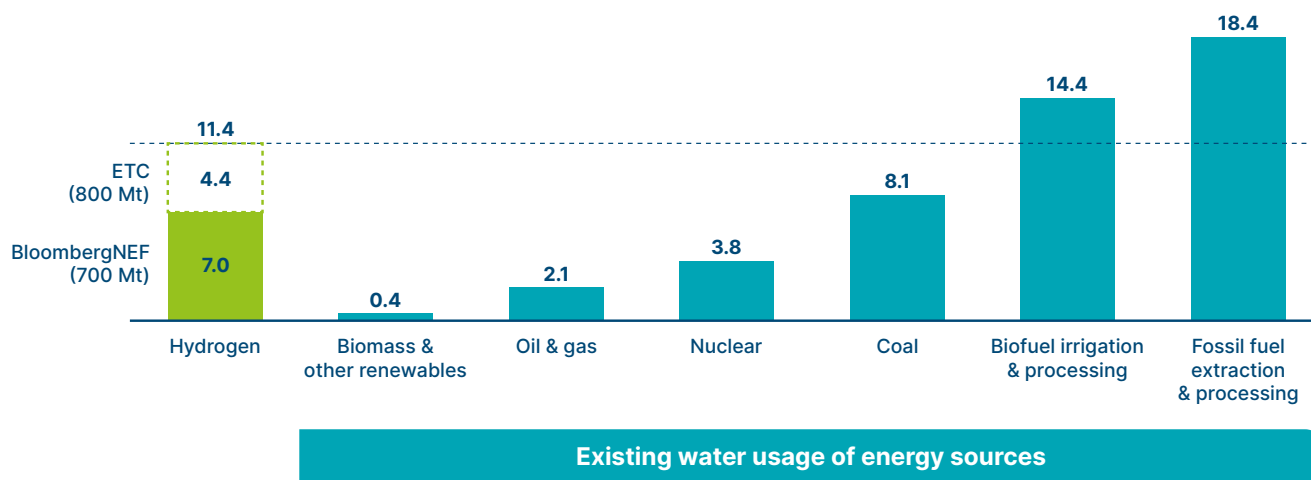

**NOTE:** The estimated water consumption for hydrogen is calculated for 100% production from water electrolysis. In the BloombergNEF scenario it is calculated based on demand of 696 Mt in the policy scenario. Water consumption for other sectors is based upon 2016 data from the IEA. Other renewables include wind, PV, geothermal and solar thermal, and excludes hydropower. Fossil fuel and biofuel numbers represent water consumption during primary energy production. All other numbers (except hydrogen) represent water consumption during power generation.

**SOURCE:** BloombergNEF (2019), *Hydrogen Economy Outlook*; IEA

Exhibit 2.10

125 Sources: Environments (2018), *Life Cycle Assessment and Water Footprint of Hydrogen Production Methods: From Conventional to Emerging Technologies*; DOE (2016), *Life-Cycle Analysis of Water Consumption for Hydrogen Production*.

126 OurWorldInData (2017), *Water Use and Stress*.

127 Extraction of water from humidity in air is too expensive in comparison (ca. \$1.35/kg). Very few regions globally would be limited by water availability for the production of clean hydrogen. Electricity transmission to the nearest location with access to water may help to overcome this bottleneck (see Section 1.3).

128 Assuming 45 kWh/kg electrolyser energy consumption.

129 ETC (2021), *Making Clean Electrification Possible: 30 years to electrify the global economy*.

130 ETC (2021), *Making Clean Electrification Possible: 30 years to electrify the global economy*.

131 BloombergNEF (2021), *1H2021 Hydrogen Market Outlook*.

# Green hydrogen ramp-up will require major increase in green electricity generation post 2030 (ca. 25% of total TWh in 2050)

Electricity use for green ramp-up  
TWh, ETC supply-side decarbonization pathway<sup>1</sup>

Illustrative scenario

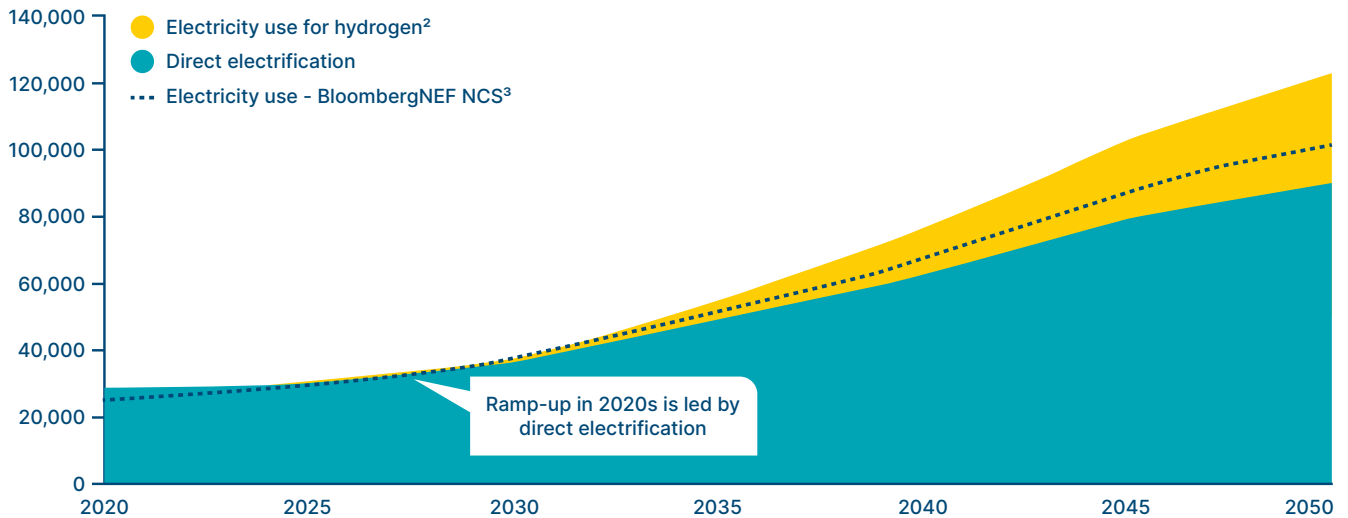

Exhibit 2.11

NOTES: <sup>1</sup> Total hydrogen demand of 800 Mt with 85% derived from green hydrogen assumed. Lower-end of hydrogen demand for power storage used. <sup>2</sup> Electricity use for hydrogen includes hydrogen and hydrogen derived (ammonia, synfuel) end-uses. <sup>3</sup> BloombergNEF *New Energy Outlook* Climate Scenario.

SOURCE: BloombergNEF (2020), *New Energy Outlook*; SYSTEMIQ analysis for the Energy Transitions Commission (2021)

## Blue hydrogen ramp-up

In theory, the potential to grow blue hydrogen is a function of natural gas and carbon storage availability. However, there is a risk that long project lead times, lack of availability of and access to local carbon storage facilities, failure to develop shared pipeline networks and public resistance to CCS could slow the pace of development. These challenges could limit the speed with which existing grey hydrogen production can be decarbonised, as well as constrain the role of blue hydrogen in meeting demand growth in the 2020s and 2030s. This would, in turn, further increase the pace at which green hydrogen production would have to scale-up in the 2020s.

Clear national strategies for the appropriate development of blue hydrogen are therefore required, even if green will dominate in the long term:

- While the overall potential CO<sub>2</sub> storage capacity globally is considered to be vast, precise geological suitability for many potential CO<sub>2</sub> storage sites is lacking.<sup>132</sup> The process of developing a potential CO<sub>2</sub> storage resource to commercial status can take between 5 and 12 years for depleted oil and gas fields and even longer for saline formations.<sup>133</sup>
- Across all sectors, there are still only 21 CCS projects operational across the world, and only about 45 under development with most currently focused on power, cement and steel, rather than blue hydrogen production. In addition, CCS projects face a number of hurdles (permitting, geological, technical) which may lead to significant delays or project cancellations.<sup>134</sup> Even if blue hydrogen will play a much smaller long-term role than green hydrogen, the pace of development needs to be massively increased to meet medium-term targets.<sup>135</sup>

<sup>132</sup> IEA estimates 8,000-55,000 Gt CO<sub>2</sub> storage capacity globally, including onshore and offshore storage sites. However, recent studies suggest that 99%+ of storage capacity is classified as “undiscovered” or “sub-commercial”. While some sites might be suitable for use as either CO<sub>2</sub> or hydrogen storage, the suitability assessment differs for CO<sub>2</sub> and hydrogen storage. In particular, depleted natural gas fields are more likely to be suitable for CO<sub>2</sub> storage as impurities may impact the purity of hydrogen stored within them (see Section 1.3). Sources: Pale Blue Dot (2020), *Global Storage Resource Assessment – 2019 Update*; IEA (2020), *Energy Technology Perspectives – Special Report on Carbon Capture Utilisation and Storage*.

<sup>133</sup> OGCI (2017), *Multinational CO<sub>2</sub> Storage Resource Assessment*.

<sup>134</sup> *Financial Times*, “Chevron turns on \$2.5bn carbon capture plant in Australia”, August 7<sup>th</sup> 2019.

<sup>135</sup> CCS offers the advantage that in a cluster-based approach multiple CO<sub>2</sub> emitting processes (blue hydrogen and for example cement, refineries) may share the same CO<sub>2</sub> transportation and storage infrastructure.

- In many cases, a significant build out of short distance CO<sub>2</sub> network infrastructure is likely to be required to transport CO<sub>2</sub> to the storage site after capture within the hydrogen production facility (IEA analysis shows that 70% of major CO<sub>2</sub> emitters in China, Europe and the United States are within 100 km of potential storage sites for CO<sub>2</sub>). Current CO<sub>2</sub> pipeline infrastructure is limited with only 8,000 km globally.<sup>136</sup>
- Public perceptions of CCS are still negative in many countries, with concerns about whether storage is truly permanent and possible impacts on the local environment. Some countries have legislative restrictions to CCS developments such as maximum yearly storage volume or stringent geographic restrictions (e.g., no onshore CO<sub>2</sub> storage).<sup>137</sup> Public policy therefore needs to create confidence via well-designed regulation and certification regimes.

Blue production can play an important role in the short term to underpin the early take-off of the hydrogen value chain, especially in regions where natural gas costs are low, CCS storage readily available, and pace of renewables growth lags – but it will require strong policy backing to significantly accelerate the pace of investment.

## Rapid ramp up of blue production in the 2020s would see blue taking a greater share of supply in next decade, and green ramping up faster in the 2030s to compensate

Illustrative scenarios

### Scenario 1: Limited role for blue

### Scenario 2: Medium role for blue

### Scenario 3: Higher role for blue

Clean hydrogen production (green and blue)  
Mt hydrogen/year

● Green hydrogen ● Greenfield blue hydrogen ● Retrofit grey hydrogen

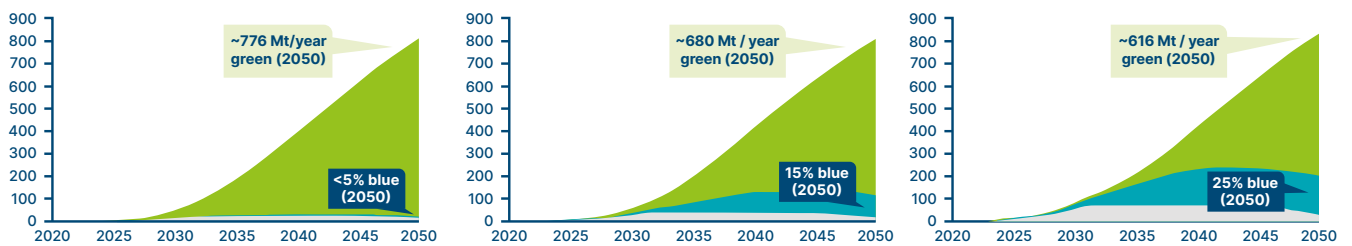

### Build rate assumption underpinning illustrative scenarios

Retrofit of existing production facilities:

ca. 40% gas plants by 2030

ca. 70% gas plants by 2030

ca. 80% coal and gas plants by 2030

New clean hydrogen production facilities:

- ca. 20 plants<sup>1</sup> constructed 2028–2038
- Max addition of plants per year: 4 in 2037, equivalent to ca. 8 GW electrolysis
- ca. 250 plants<sup>2</sup> constructed 2028–2038
- Max addition of plants per year: 40 in 2036, equivalent to ca. 110 GW electrolysis
- ca. 475 plants<sup>3</sup> constructed 2028–2038
- Max addition of plants per year: ca. 60 in 2036, equivalent to ca. 210 GW electrolysis or ca. 25% of today's dedicated grey hydrogen production

Clean hydrogen production in the 2020s (green and blue)  
Mt hydrogen/year

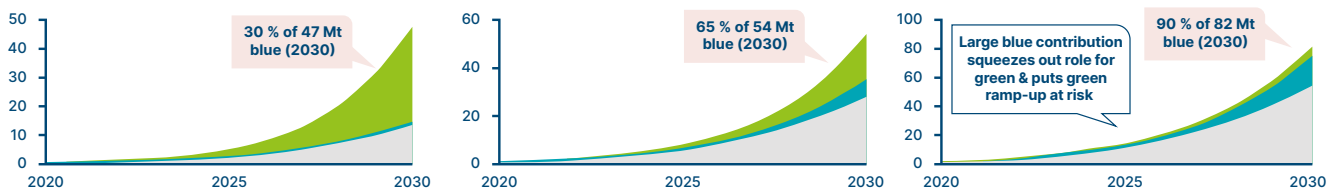

NOTES: Details on the models methodology describing these scenarios can be found in the appendix. Historical build rates for green and blue projects were based on public databases. Size of plant: 1) 500 2) 700, 3) 800 tons of hydrogen/day

SOURCES: SYSTEMIQ analysis for the Energy Transitions Commission (2021); IEA (2020), *Hydrogen Projects Database*; IEA (2020), *World large-scale CCUS facilities operating and in development, 2010-2020*

Exhibit 2.12

<sup>136</sup> IEA (2020), *Energy Technology Perspectives – Special Report on Carbon Capture Utilisation and Storage*.

<sup>137</sup> Navigant, 2019, *Gas for climate*.

## Illustrative scenario for green versus blue hydrogen

The actual balance between green and blue hydrogen will reflect future trends in technology and cost, and will vary in line with specific national and regional circumstances. As discussed in Section 1.2, access to low-cost natural gas and CCS infrastructure will favour blue production (e.g., in Russia), while access to cheap, large-scale renewable generation and low-cost electrolyser equipment will favour green production (e.g., in Chile, Australia, China).

It is therefore neither possible nor necessary to provide a precise forecast of what balance will result at the global level. But it is useful to consider scenarios which illustrate broad orders of magnitude and likely limits (Exhibit 2.12, further details in appendix):

- Given the long-term cost trends described in Chapter 1 and the prospects for rapid green hydrogen cost reduction in the 2020s, it is highly likely that green hydrogen will account for a large majority of total production (80%+) in 2050, and that it will become increasingly competitive in the late 2020s/early 2030s as low-cost renewables increasingly enable low-cost green production in most geographies.
- Blue hydrogen will almost certainly play a role in the retrofit of existing grey hydrogen production, implying an absolute minimum of at least a few percent of 2050 production, but scenarios up to 25% of total production are possible.
  - Our low case scenario illustrates a pathway in which almost all demand growth would be met by green hydrogen production, with majority of blue hydrogen from the retrofit of existing grey hydrogen production and very minimal greenfield blue hydrogen. It would entail a blue production of about 25 Mt by 2050.
  - Our higher case would require investment in new grey facilities to immediately cease, with CCS retrofitted to 80% of existing hydrogen production (with 80% converted by 2030)<sup>138</sup> and a massive acceleration in new blue hydrogen projects in the 2020s. New blue projects would peak in the 2030s with ca. 60 new projects coming online in a single year<sup>139</sup>, equivalent to ca. 25% of today's total grey hydrogen production being built in just one year.<sup>140</sup> However, beyond 2030, the pace of new blue production is likely to decline considerably as the economics of green production improve and green hydrogen becomes the lower-cost option in most locations.
  - In the medium scenario, retrofitting would be limited to 70% of sites<sup>141</sup> and new blue projects per year would peak at 40 new plants.<sup>142</sup> It is important to note, however, that, even in this medium scenario with blue hydrogen accounting for 15% of 2050 total production, this would imply an increase of ca. 60% from today's 70 Mt of dedicated grey hydrogen production,<sup>143</sup> and a need for almost 1 Gt per year of CCS for hydrogen production only (compared to ca. 40 Mt per year across all sectors of the economy today<sup>144</sup>).<sup>145</sup>

The factors which could result in the higher blue production scenario are set out in Exhibit 2.13. Exhibit 2.14 places the medium production mix scenario alongside the demand scenario shown earlier to give a broad indication of the how the hydrogen economy could develop over the next 30 years.

138 Scenarios assume existing grey hydrogen plants are either retrofitted with CCS (with an increasing pace of roll-out) or retire by mid-2030s (due to bans on carbon-intensive production). In the low/medium scenario, 70% of current production considered candidates for retrofit (i.e., primarily SMR production, and assuming that CCS not available in all current grey hydrogen production facilities); in the high scenario, coal-based production sites are also considered.

139 With each 800 tonne/day blue hydrogen capacity.

140 Delivering this would require almost 400 projects under early development by the end of the 2020s vs. ca. 5 in last 5 years, and for a parallel acceleration of project delivery to 5 years from early project development to completion.

141 70% is based on excluding coal based grey hydrogen production and assuming that CCS is not available in all current SMR production sites.

142 With each 700 tonne/day blue hydrogen capacity.

143 As discussed in Section 1.1 and Exhibit 1.2, ca. 70 Mt of hydrogen are produced via predominately fossil routes (99%+) in a dedicated production facility and 45 Mt are produced as a by-product. In total, the use of hydrogen today is therefore ca. 115 Mt (based on numbers from 2018). Source: IEA (2019), *The future of hydrogen*

144 Global CCS Institute (2020), *Global status of CCS 2020*.

145 Based on today's hydrogen production emissions intensity.



# What would you have to believe for a larger role for blue production?

Exhibit 2.13

	Greater <b>transition</b> role for Blue...	Greater <b>long term</b> role for Blue...
Blue economics more attractive	<ul style="list-style-type: none"> <li>Declining <b>natural gas</b> costs</li> <li><b>Rapid growth in CCS</b> storage close to existing hydrogen production sites</li> <li><b>Rapid retrofit</b> of all existing hydrogen production</li> <li><b>Rate of conversion</b> from early project development to completed projects <b>increases and timelines shorten</b> as blue hydrogen production becomes more mainstream</li> <li><b>Slower retiring</b> of retrofitted CCS assets (&gt;20 years)</li> <li>Stronger efforts to <b>build out blue export infrastructure</b> in gas exporting nations (i.e. ammonia ships)</li> </ul>	<ul style="list-style-type: none"> <li>Some geographies where <b>blue stays lowest cost production route in long term</b> due to very low local gas price, while renewable energy availability remains insufficient / high cost</li> </ul>
Green cost declines stall	<ul style="list-style-type: none"> <li><b>Pace of VRE roll out insufficient</b> to meet increased demands of mass-electrification and hydrogen production, limiting the availability of low-cost zero-carbon electricity (e.g. due to NIMBY-ism)</li> <li><b>Electrolyser CAPEX</b> cost declines lag forecasts</li> </ul>	<ul style="list-style-type: none"> <li><b>Transportation costs prohibit import</b> of low cost green hydrogen from neighbouring regions</li> </ul>

## In a mass-electrification scenario, what could the scale up of the hydrogen economy look like?

Exhibit 2.14

Scenario 2: ~85% 2050 supply green, ~15% blue

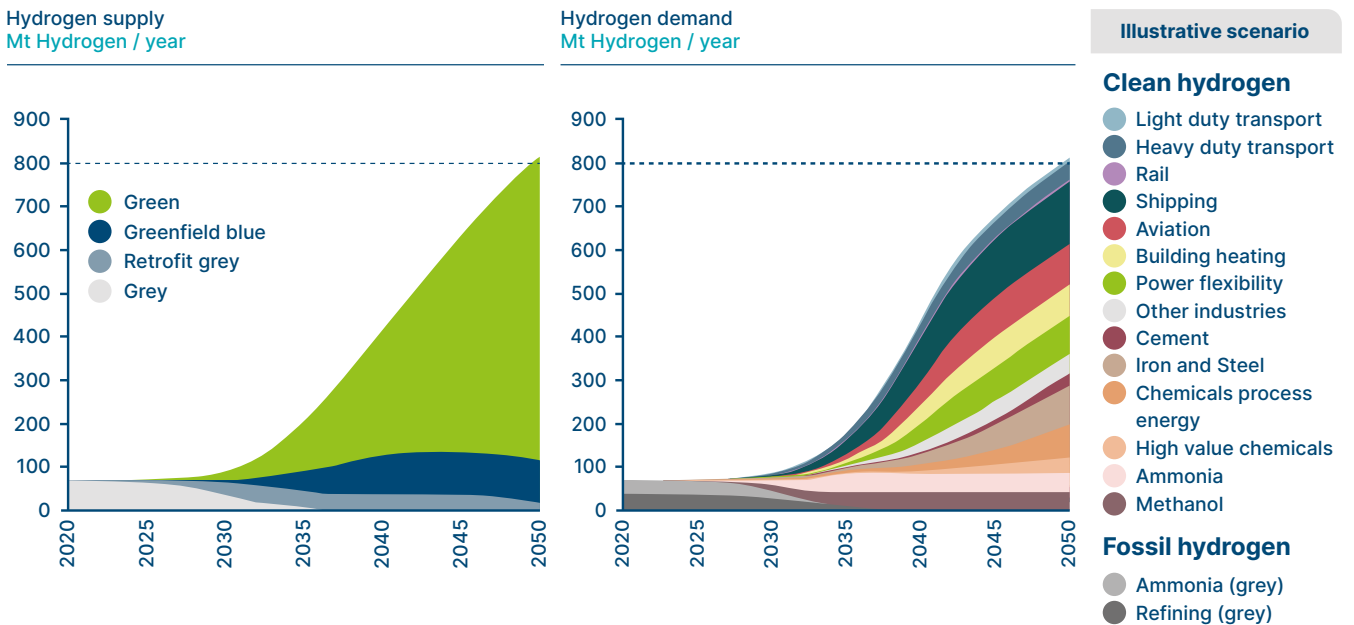

SOURCE: SYSTEMIQ analysis for Energy Transitions Commission (2021)

## IV. Developing hydrogen clusters

The sections above described the broad shape of the future hydrogen economy and highlighted the importance of achieving significant momentum in the 2020s to ensure rapid large-scale take-off in the 2030s. It also emphasised the importance of setting a coherent pace of supply and demand ramp-up.

This should to a large extent be done using whole-economy policy levers such as carbon prices or fuel duties, as well as broad carbon-related regulations applied to entire sectors (e.g., fuel mandates or phase-out dates for fossil fuel technologies). However, the specific challenges involved in developing the hydrogen value chain argue for focusing also on the development of initial “hydrogen clusters”, where the simultaneous development of hydrogen production, storage, transport and end use can de-risk investment and drive self-reinforcing developments.

The details of potential clusters – i.e., hydrogen production routes, mix of end uses, size, etc. – will depend on specific geographies and initial circumstances. But, in general, a focus on cluster-based development can:

- Provide hydrogen producers with greater certainty on local hydrogen demand and de-risk their business case by diversifying off-takers;
- Support the simultaneous development of several different end use applications, rapidly achieving economies of scale in local hydrogen production;
- Accelerate the development of new uses for hydrogen at the same time as decarbonising existing grey hydrogen production;
- Minimise the initial need for investments in large-scale long-distance pipeline – with shorter-distance transport infrastructure costs shared between several potential users;
- Promote early development of storage infrastructure, whether steel tanks or large capacity salt and rock caverns, with costs shared between different users;
- Reduce permitting needs and complexity by increasing scale and coordinated efforts across production, storage and end use value chain;
- Focus public support on developments which will benefit several companies and sectors.

### Hydrogen cluster archetypes

Multiple variants of hydrogen clusters can be envisaged, but 4 archetypes will play a particularly crucial role (Box F):

- **Refining, petrochemical and fertiliser clusters**, with activities already co-located because of shared gas supply systems and exchange of intermediate products, and where decarbonisation of already existing grey hydrogen is a key priority.
- **Ports** which need to support future shipping decarbonisation, are also nodes for long-distance trucking or rail connection, are often located close to heavy industry sites, and offer port operations for initial demand (e.g., drayage).
- **Non-coastal transport nodes**, often close to **major cities**, where demand from aviation, road transport and warehousing could develop.
- **Steel plants**, which require such large quantities of hydrogen that their demand alone will enable economies of scale, but which can also be anchors for other users of clean hydrogen to locate nearby – e.g., a filling station for trucks that are transporting goods to and from the steel plant.<sup>146</sup>

<sup>146</sup> Range of other industrial decarbonisation ‘clusters’ possible includes mining and hydrogen co-firing in power plants.

Such clusters are already emerging in many locations as key nodes for hydrogen development. The ports of Amsterdam, Rotterdam and Zeeland are developing plans for green and blue hydrogen with demand from existing refineries, ammonia and steel plants (Box F).<sup>147</sup> In Chile, green hydrogen clusters around ammonia production for explosives, fertiliser, and use as a shipping fuel are being developed. In Spain, consortia are planning clean hydrogen cluster focused on the decarbonisation of the ceramics industry which has high demands for high temperature heat. In the UK, an industrial cluster at Humber and Teesside will combine CCS from multiple industrial sources with blue hydrogen production.<sup>148</sup>

Beyond, favourable locations for the development of hydrogen clusters include Australia, Chile, China (inner Mongolia) for green hydrogen, and Russia, Saudi Arabia and the United Arab Emirates for blue hydrogen. This list is non-exhaustive.

<sup>147</sup> The oxygen by-product of green hydrogen production is used in the basic-oxygen furnace of the steel plant.

<sup>148</sup> Sources: Engie, "ENGIE and Mining3's renewable hydrogen powertrain project receives funding support from Chilean economic development agency", August 5<sup>th</sup> 2020; ICIS, "Over 540MW of green hydrogen capacity announced in Spain during February, March 1<sup>st</sup> 2021; NetZeroTeesside, "Funding secured to accelerate development of UK's first decarbonised industrial clusters on the east coast of England", March 17<sup>th</sup> 2021.



# Four archetypes for hydrogen clusters based on “early demand” use cases

1 Port	2 City	3 Refining & Fertiliser	4 Steel
<p>Ports<sup>1</sup> as infrastructure hubs for import/export of feedstocks and goods.</p> <p>Core off-taker:</p> <ul style="list-style-type: none"> <li>• <b>Shipping (Ammonia)</b></li> </ul> <p>Often co-located with:</p> <ul style="list-style-type: none"> <li>• <b>Refining &amp; Fertiliser</b> Import/export of LNG for these industries</li> <li>• <b>Steel</b> Import/export of feedstocks and products</li> <li>• <b>Road Transport</b> Container transport</li> <li>• <b>Aviation</b> Coastal transport hub</li> <li>• <b>Forklifts &amp; Ground Operations</b> Container/goods handling</li> <li>• <b>Option for blending</b> dependant on trade-offs (see Box B) Coincide with LNG storage</li> </ul>	<p>Continental cities serve as non-coastal hub for transport and are often well connected to gas grid infrastructure.</p> <p>Core off-takers:</p> <ul style="list-style-type: none"> <li>• <b>Aviation</b></li> <li>• <b>Long-haul trucking &amp; buses</b></li> <li>• <b>Option for low % H<sub>2</sub> blending</b> into natural gas grid dependant on trade-offs (see Box B)</li> </ul> <p>Often co-located with:</p> <ul style="list-style-type: none"> <li>• <b>Refining &amp; Ammonia</b> As large natural gas demand sites commonly close to gas storage/import sites</li> <li>• <b>Forklifts &amp; Ground Operations</b> Heavy transport in mines</li> </ul>	<p>Refineries and fertiliser production are frequently co-located and require large amounts of hydrogen.</p> <p>Core off-taker:</p> <ul style="list-style-type: none"> <li>• <b>Refining &amp; Fertiliser</b></li> </ul> <p>Often co-located with:</p> <ul style="list-style-type: none"> <li>• <b>Ports</b></li> <li>• <b>Gas storage facilities</b> – option for low % H<sub>2</sub> blending into natural gas grid dependant on trade-offs (see Box B)</li> </ul>	<p>Hydrogen-DRI steel production as major hydrogen off-taker (medium sized steel site requires approximately ~120 kt H<sub>2</sub>/year).</p> <p>Core off-taker:</p> <ul style="list-style-type: none"> <li>• <b>Hydrogen-DRI steel production</b></li> </ul> <p>Often co-located with:</p> <ul style="list-style-type: none"> <li>• <b>Ports</b></li> </ul>
		<p>• <b>Refining, Fertiliser and Steel</b> offer sufficient off-take to operate on stand-alone basis, but co-location enables shared off-take</p>	
		<p>• <b>Road Transport</b> Dependant on long-term role of hydrogen in road transport &amp; hydrogen refuelling infrastructure network requirements</p>	

## Illustrative cluster size

Large to very large (~100- >1000 t/day)	Small to very large (~1 - >1000 t/day)	Medium to Large (~50-400 t/day)	Large (100-300 t/day)
---	--	---------------------------------	-----------------------

## Existing pipeline of projects exemplifies these archetypes:

<p><b>Port of Amsterdam:</b></p> <ul style="list-style-type: none"> <li>• Partners: Nouryon, Tata Steel</li> <li>• 100 MW electrolysis</li> <li>• Oxygen bi-product from electrolysis will be used in steel production</li> </ul> <p><b>Port of Rotterdam:</b></p> <ul style="list-style-type: none"> <li>• 1.2 Mt clean hydrogen production via green and blue route by 2030</li> <li>• Wide variety of end-uses targeted in several consortia and pilots including shipping, trucking and aviation</li> </ul> <p><b>North Sea Port<sup>2</sup>:</b></p> <ul style="list-style-type: none"> <li>• Partners: 500 MW electrolysis</li> <li>• End-users include refinery, ammonia and steel plant in proximity to port</li> </ul>	<p><b>Aberdeen Hydrogen Hub, Scotland:</b></p> <ul style="list-style-type: none"> <li>• Hydrogen refuelling stations and deployment of hydrogen powered L/M/HDV</li> <li>• Feasibility study to expand to building heating and industry</li> </ul> <p><b>Hydrogen Cities, South Korea:</b></p> <ul style="list-style-type: none"> <li>• 4 cities as candidate cities for the hydrogen economy</li> <li>• Road transport refuelling infrastructure</li> <li>• Hydrogen grid for building heating/cooling</li> </ul> <p><b>Liverpool &amp; Manchester, UK:</b></p> <ul style="list-style-type: none"> <li>• Partners: Consortium lead by Cadent and Progressive Energy</li> <li>• Blue hydrogen for gas grid blending combined with local industry and transport</li> </ul>	<p><b>Puertollano, Spain<sup>3</sup>:</b></p> <ul style="list-style-type: none"> <li>• Partners: Iberdrola and Fertiberia</li> <li>• 20 MW electrolysis (2021)</li> <li>• Green hydrogen used to co-feed (10%) into existing ammonia plant</li> </ul> <p><b>Lingen, Germany<sup>3</sup>:</b></p> <ul style="list-style-type: none"> <li>• Partners: BP and Oersted</li> <li>• 50 MW electrolysis</li> <li>• Green hydrogen to replace 20% of grey hydrogen in refinery</li> </ul> <p><b>Antofagasta, Chile<sup>3</sup>:</b></p> <ul style="list-style-type: none"> <li>• Partners: Engie and Enaex</li> <li>• 1600 MW electrolysis</li> <li>• For local ammonium nitrate plant and export market</li> </ul> <p>Large projects such as Australian Renewable Energy Hub<sup>4</sup> and NEOM<sup>5</sup> are in early planning stages</p>	<p><b>Lulea, Sweden:</b></p> <ul style="list-style-type: none"> <li>• Partners SSAB, Vattenfall, LKAB</li> <li>• Pioneering hydrogen-direct reduction (DRI) technology</li> <li>• Commencing early commercial production in 2026</li> </ul> <p><b>Duisburg, Germany:</b></p> <ul style="list-style-type: none"> <li>• Partners: Thyssenkrupp, RWE</li> <li>• 100 MW electrolysis</li> <li>• Co-feed of hydrogen into coal-powered blast-furnace as first step prior to conversion to DRI plants</li> </ul> <p><b>Dunkirk, France:</b></p> <ul style="list-style-type: none"> <li>• Partners: AcelorMittal, Air Liquide</li> <li>• Development of hydrogen-DRI and hybrid BF/DRI technology</li> </ul>
---	---	---	---

**NOTES:** <sup>1</sup> Particular focus on coastal ports due to much bigger size compared to inland ports; <sup>2</sup> Partners: Dow, Yara, Zeeland Refinery, ArcelorMittal, Ørsted and North Sea Port; <sup>3</sup> Early projects only have one-offtaker, but are in principle located in close proximity to additional refinery or fertiliser production facilities; <sup>4</sup> Partners: InterContinental Energy, CWP Energy Asia, Vestas, Pathway Investments. Up to 23 GW electrolysis for ammonia production in early planning stages. <sup>5</sup> Partner: Air Products, ACWA Power, Thyssenkrupp, Haldor Topsøe. Target: 650 t/day H<sub>2</sub> production to produce 1.2 Mt ammonia / year

**SOURCES:** Port of Amsterdam, “Nouryon, Tata Steel, and Port of Amsterdam partner to develop the largest green hydrogen cluster in Europe”, October 18<sup>th</sup> 2018; Port of Rotterdam, “Port of Rotterdam becomes international hydrogen hub”, May 7<sup>th</sup> 2020; North Sea Port, “Ørsted North Sea Port to develop one of the world’s largest sustainable hydrogen plants for Dutch and Belgian industry”, April 1<sup>st</sup> 2021; Aberdeen City Council, “H<sub>2</sub> Aberdeen”, retrieved April 2021; FuelCellsWorks, “Korean Government announces its selection of World’s first hydrogen cities”, January 6<sup>th</sup> 2020; HyNet North West (2020), “Unlocking net zero for the UK”; Iberdrola, “Iberdrola and Fertiberia launch the largest plant producing green hydrogen for industrial use in Europe”, July 24<sup>th</sup> 2020; Reuters, “BP, Ørsted launch green hydrogen project at German oil refinery”, November 10<sup>th</sup> 2020; Power Engineering International, “First green hydrogen projects emerge in Chile”, October 5<sup>th</sup> 2020; The Chemical Engineer, “Australian Government backs renewable energy hub”, October 23<sup>rd</sup> 2020; AirProducts, “Air Products, ACWA Power and NEOM Sign Agreement for \$5 Billion Production Facility in NEOM Powered by Renewable Energy for Production and Export of Green Hydrogen to Global Markets”, July 7<sup>th</sup> 2020; Hybrit, “SSAB, LKAB and Vattenfall to begin industrialization of future fossil-free steelmaking by establishing the world’s first production plant for fossil-free sponge iron in Gällivare”, March 24<sup>th</sup> 2021; Thyssenkrupp, “Green hydrogen for steel production: RWE and thyssenkrupp plan partnership”, June 10<sup>th</sup> 2020; AcelorMittal, “ArcelorMittal Europe to produce ‘green steel’ starting in 2020”, October 13<sup>th</sup> 2020.

## Factors determining optimal cluster development

The potential for cluster development, and the optimal balance between green and blue production in a given cluster, will reflect the specific mix of activities already present in a given region, local resources, and policy priorities. Availability or ease of development of short-distance pipeline links and shared storage capacity<sup>149</sup> will be important in almost all cases, while:

- Green hydrogen production will tend to dominate where renewable electricity is available at low cost – whether because of land availability for solar and onshore development, or because coastal location facilitates the use of offshore wind. Green production also makes it easier to develop in a modular fashion, with electrolyser capacity growing gradually over time.<sup>150</sup>
- Blue hydrogen production will tend to dominate in locations with established gas supply infrastructure and will require access not only to adequate hydrogen storage but also carbon storage facilities. It may be most appropriate where there is already existing grey hydrogen production to which CCS can be added.

National or regional hydrogen strategies should therefore identify high-potential locations, taking into account both hydrogen supply potential and key end use applications which might develop there, and use focused public support to drive initial growth.

- For instance, ETC India analysis has identified 46 sites with high potential for rapid clean hydrogen demand growth, with 4 areas in particular which combine early demand opportunities with cheap renewable resources to support green hydrogen production. These are Gujarat, which has major opportunities in oil refining, fertilisers, caustic soda and, to a lesser extent, steel; Orissa and West Bengal, where steel production is very significant; and Maharashtra, with major potential for early decarbonisation of oil refining and fertiliser production (Exhibit 2.15).

### Spatial analysis in India identified 46 favourable clean hydrogen industrial cluster locations

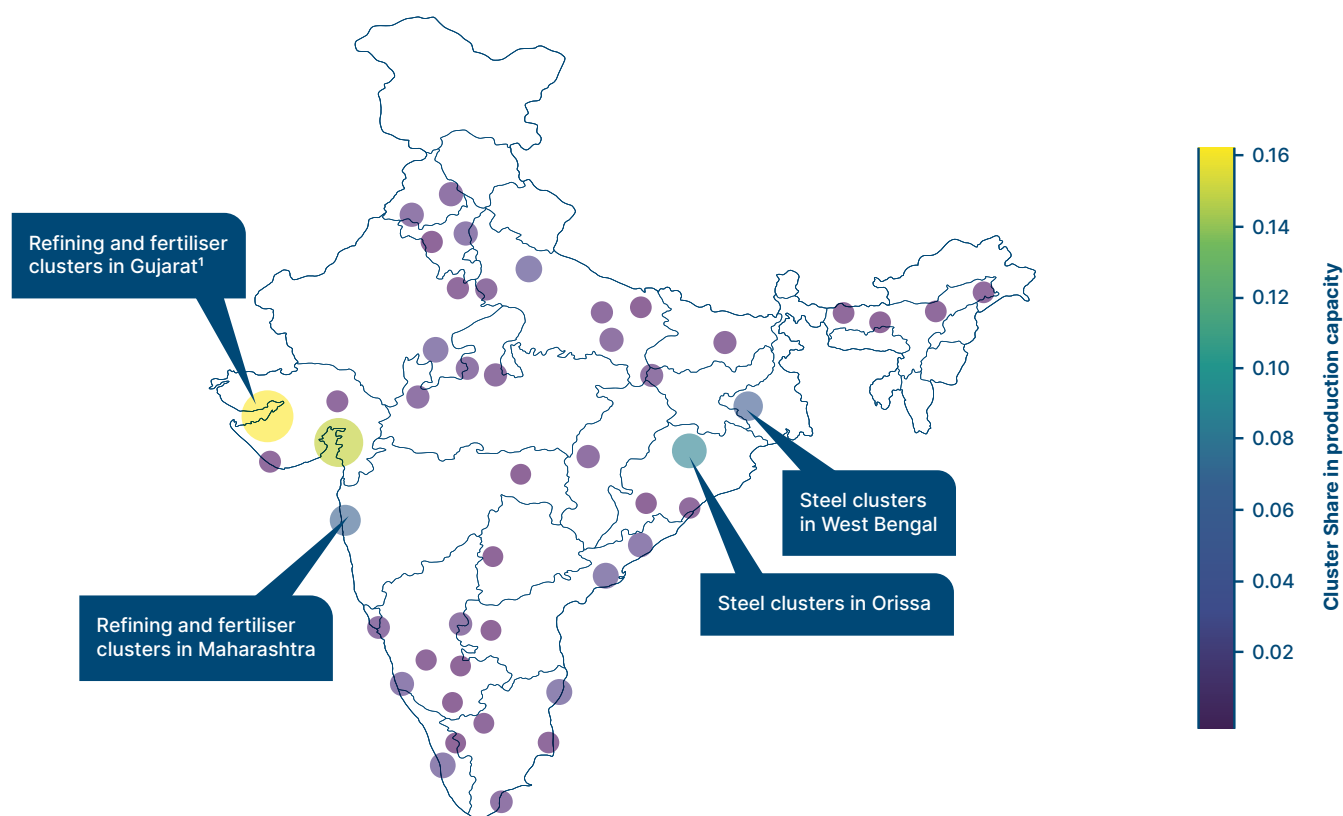

Exhibit 2.15

**NOTES:**<sup>1</sup> There is also a significant chlor-alkali industry in Gujarat which may offer by-product clean hydrogen for these clusters.

**SOURCE:** TERI/ETC India analysis published in TERI (2020), *The Potential Role of Hydrogen in India*

<sup>149</sup> Larger industrial clusters (in particular for green hydrogen) will require geological hydrogen storage due to the prohibitively high costs of steel tanks for large volumes (>1000 tonnes hydrogen). These may however not be available in all locations as discussed in section 1.3.

<sup>150</sup> Such a stepwise extension is commonly proposed in green hydrogen projects, for example a consortium in Copenhagen (Copenhagen Airports, A.P. Moller - Maersk, DSV Panalpina, DFDS, SAS and Ørsted) plans electrolyser capacities of 10MW by 2027, 250 MW by 2027 and 1.3 GW in 2030 to produce sustainable fuel for buses, trucks, maritime vessels and airplanes.

- Meanwhile, initial mapping of Southern Europe has identified 30 sites each with a potential offtake of 100 to 1000 tonnes per day, and an aggregated total short-term demand of 5 Mt per annum (if all identified sites were to be converted; Exhibit 2.16).

## Location of potential hydrogen clusters in the Southern Europe

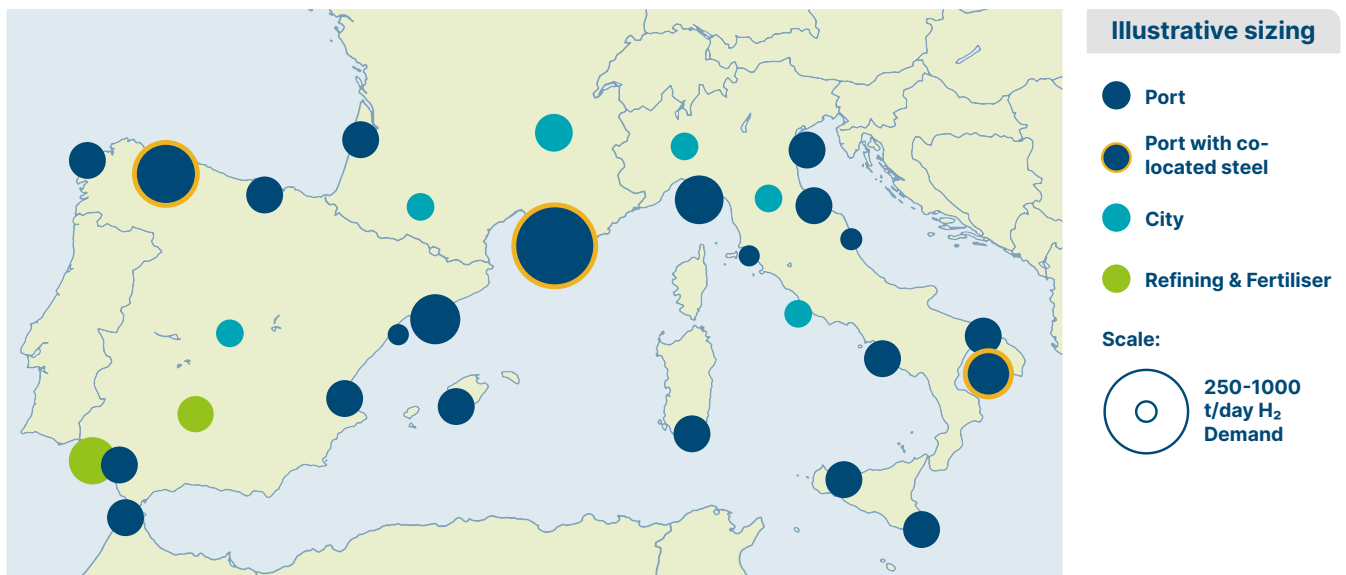

Exhibit 2.16

**NOTE:** Analysis was only carried out for Italy, France, Spain. Forklift, ground transport and long-haul busses & trucks are added to every port and city cluster. Single refineries or fertilizer plants were not highlighted. Illustrative sizes are based on approximate average sizes of industrial facilities and transport hubs.

**SOURCES:** SYSTEMIQ analysis for Energy Transitions Commission (2020) based on public sources retrieved November 2020: European Environment Agency, "European Pollutant Release and Transfer Register"; Fertiliser Europe, "Map of major fertilizer plants in Europe"; Eurofer, "Where is steel made in Europe?"; European Commission, "TENec Interactive Map Viewer" and "Projects of common interest – Interactive map"; Gie, "Gas Infrastructure Europe"; CNMC, "General Overview of Spanish LNG Sector"; McKinsey, "Refinery Reference Desk – European Refineries"; Frackracker Alliance, "Map of global oil refineries"

## V. Developing transportation and storage infrastructure

Encouraging initial developments within hydrogen clusters will reduce the extent to which early take-off of the clean hydrogen economy depends on major new investments in hydrogen transport infrastructure. As discussed in Chapter 1, transportation of hydrogen can add significant costs to the delivered cost of hydrogen. Over time, however, more extensive hydrogen distribution networks may be required, enabling a more dispersed production, storage and use of hydrogen. These will likely involve the partial retrofitting of existing gas networks to support hydrogen transport.

Required investments in storage will also tend to increase over time, particularly if and when hydrogen starts playing a major role in providing seasonal balance within the power system. Considering significant differences in the availability of large-scale geological hydrogen storage (see Section 1.3), strategic planning for these infrastructure investments on government level will be required.

National strategies should also consider whether to position themselves as hydrogen export or import nation – and develop international collaborations accordingly. For example, Germany has actively indicated its interest to import clean hydrogen, whereas Chile aims to position itself as a hydrogen-exporting nation.

As a result, the relative importance of transport and storage infrastructure is likely to increase over time. As Section 2.7 will suggest, investments in that infrastructure could become as significant as those required for green/blue hydrogen production assets, while always remaining much smaller than the investments needed to build the zero-carbon electricity generation capacity able to support a massive scale-up of green hydrogen production. However, as described in Section 1.3, these investment will remain far below the large-scale transportation investments required for today's international trade in fossil fuels.

## VI. Safety, quality and low-carbon standards

As described in Chapter 1, hydrogen can technically be produced in a zero-carbon (green) fashion or in a very-low-carbon (blue) way. It presents certain safety risks and considerations, as does ammonia, although it is clearly possible for both to be used safely. In addition, hydrogen can be produced in sufficiently pure forms to support all the end use applications considered in previous chapters.<sup>151</sup> However, a massively increased role for hydrogen within a zero-carbon global economy will require international rules and standards on safety and purity, together with clear standards on GHG emissions.

- **Safety standards:** Hydrogen is already used extensively in large-scale industrial applications despite its high flammability. Similarly, ammonia is safely produced, stored and transported globally today despite its high toxicity. Nevertheless, international standards need to be further extended for hydrogen and its derived fuels: i) to enforce minimum hydrogen leakage, which is important from both a safety and climate change perspective (see Section 1.1);<sup>152</sup> ii) to support end-use applications (e.g., international regulation to enable ammonia as shipping fuel) to facilitate the growth of hydrogen demand. Local standards and certification regimes will in addition be required if hydrogen is to be used extensively in multiple smaller-scale residential and transport applications. These regimes should provide public assurance that hydrogen can be safely deployed in all applications, which will be critical to securing high levels of social acceptance.
- **Quality standards:** Standards for hydrogen purity are needed to facilitate market development and international trade. This should include assessment of the residual quantities of CO<sub>2</sub> and CO as well as other impurities in blue hydrogen, and of oxygen in green hydrogen. Some applications can operate with lower-purity hydrogen (e.g., steel production) while others (e.g., uses in fuel cells) require very high purity. Different supply chains and markets for higher-quality hydrogen, and simpler methods to measure impurities are needed, to meet the needs of an increasingly diversified set of off-takers.
- **Clean hydrogen standards:** To ensure that a switch to hydrogen brings maximum climate benefits, it is vital to develop standards which define how truly low/zero-carbon different sources of hydrogen are (and as a result how low/zero-carbon are the ammonia and other products derived from the hydrogen). Certification schemes for must incorporate full lifecycle emissions, including, in the case of blue hydrogen, residual CO<sub>2</sub> emissions not captured by CCS and methane leakage occurring before and during production. (see Section 1.2 and Section 3.7).

Standardisation needs to go hand in hand with robust (and currently inexistent) tracing and accounting of the different technical and carbon-intensity characteristics of hydrogen and its derived products. For example, ammonia derived from low-carbon hydrogen needs to be certified as low-carbon ammonia to enable significant emissions reduction (and justify a potential cost-premium on the market).

<sup>151</sup> Hydrogen Safety Panel (2020), *Safety Planning for Hydrogen and Fuel Cell Projects*; Green Shipping Programme (2021), *Ammonia as a marine fuel safety handbook*.

<sup>152</sup> Hydrogen leakage can have negative impacts on stratospheric ozone, some small global warming effects (though trivial compared with those from methane leakage and fossil fuel combustion) and appliances need to be designed in different manner compared to natural gas to minimise NO<sub>x</sub> emissions (toxic and potent greenhouse gases). Sources: BEIS (2018), *Hydrogen for heating: atmospheric impacts*. Element Energy and Jacobs (2018), *Industrial Fuel Switching Market Engagement Study*.

## VII. Total investment needs

Building a hydrogen economy which accounts for 15 to 20% of total final energy demand, with use increasing 5-7 times from today's 115 Mt, will require very large investments. It is important to realise that by far the largest investments are not in the hydrogen production and use system itself, but in the electricity system required to support massive increase in green hydrogen production.

Exhibit 2.17 shows estimates of the total investment needs over the next 30 years:

- In total, investments in the hydrogen value chain could amount to almost \$15 trillion between now and 2050, peaking in the late 2030s at around \$800 billion per annum.<sup>153</sup>
- Of this, however, 85% relates to the required increase in clean electricity generation. In total, investments required in power generation for green hydrogen production could amount to over \$12 trillion over the next 30 years, an average of \$0.4 trillion per annum.<sup>154</sup>
- Only 15% – reaching a maximum of ca. \$140 billion per annum in the late 2030s – is related to investment in electrolyzers, blue hydrogen production facilities, or hydrogen transport and storage infrastructure.
- Additional investments will also be required in hydrogen-using sectors, though in many cases this simply replaces the investment which would otherwise be required in another equipment (e.g., ammonia-burning ship engines instead of fuel oil engines). Those investments might be slightly higher-cost than the fossil fuels-based alternatives in the early stages of the transition – i.e., until economy of scale and learning curve effects are achieved in hydrogen-using equipment manufacturing – and could happen at a faster pace than business-as-usual stock turnover.

The very large power system investments to support green hydrogen production would be on top of the investments required to support the massive increase in direct electricity use (from around 25,000 TWh to around 90,000 TWh) described in the parallel ETC clean electrification report.<sup>155</sup> It is therefore vital that strategies for the development of the

<sup>153</sup> The average investment need over 30 years is ca. \$500 billion per year which is on the same order of magnitude as upstream oil and gas spending during the last 10 years (\$400-600 billion per year). Source: IEA (2020), *World Energy Investment 2020*.

<sup>154</sup> In some instances, additional transmission infrastructure may also be required, e.g. in the case of dedicated renewable power from offshore wind.

<sup>155</sup> ETC (2021), *Making Clean Electrification Possible: 30 years to electrify the global economy*.





hydrogen economy are underpinned by public policies which ensure the massive expansion of green electricity supply required to support an economy in which direct and indirect electricity use will together account for over 85% of all final energy use.

## Cumulative investment needs amount to ~\$15 trillion until 2050 for supply ramp-up with peak at \$800 billion per year, dominated by renewable electricity production (~85%)

Annual investment need for hydrogen economy  
\$ billion

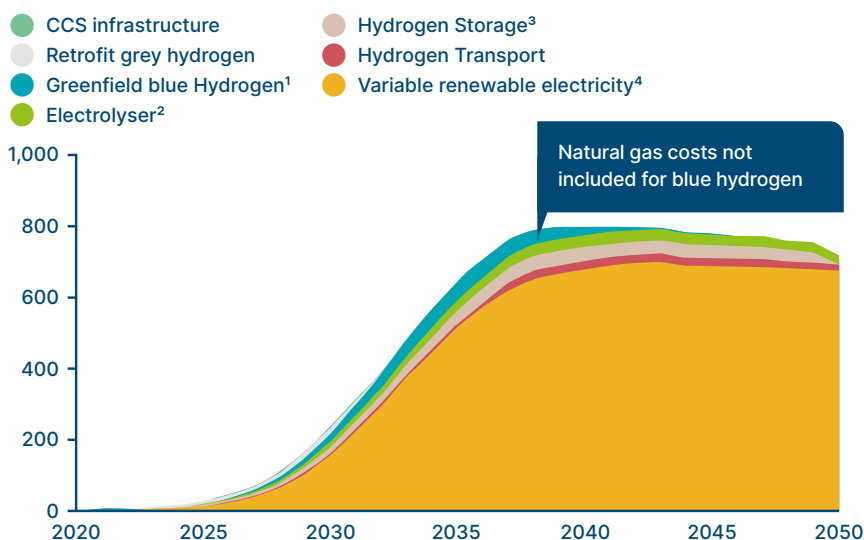

Relative cost contributors  
\$ billion

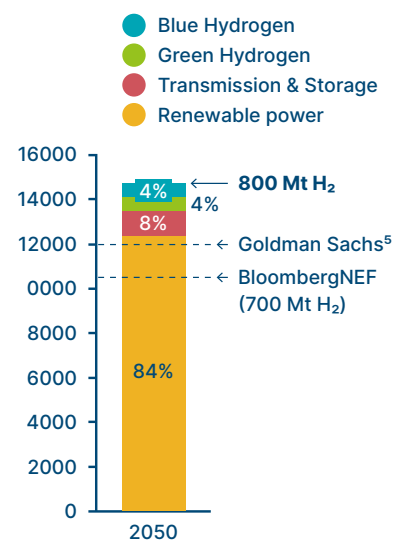

**NOTES:** The investment is assumed to take place in the year the plant is going in operation. Used middle ramp-up scenario with 85% green and 15% blue hydrogen.

<sup>1</sup> Blue hydrogen cost: \$ 0.1 billion/TWh.

<sup>2</sup> Learning rate model for electrolyser CAPEX assuming 18% learning rate, 200 MW cumulative installed capacity (2020), 1200 \$ / kW CAPEX (2020). Average utilisation factor: 50%.

<sup>3</sup> Assume 20% of global hydrogen demand needs to be stored.

<sup>4</sup> Assumed capacity split (in terms of GWh produced) of 33% PV, 53% onshore wind, 13% offshore wind. Used BloombergNEF cost predictions for VRE production (median cost of lowest 1/3 globally in terms of cost) with global average fleet load factors.

<sup>5</sup> Hydrogen demand volume in 2050 unknown.

**SOURCE:** Goldman Sachs (2020), *Green Hydrogen - The next transformational driver of the Utilities industry*; BloombergNEF (2020), *Hydrogen Economy Outlook*. Element Energy (2019), *Hydrogen production with CCS and bioenergy*

Exhibit 2.17

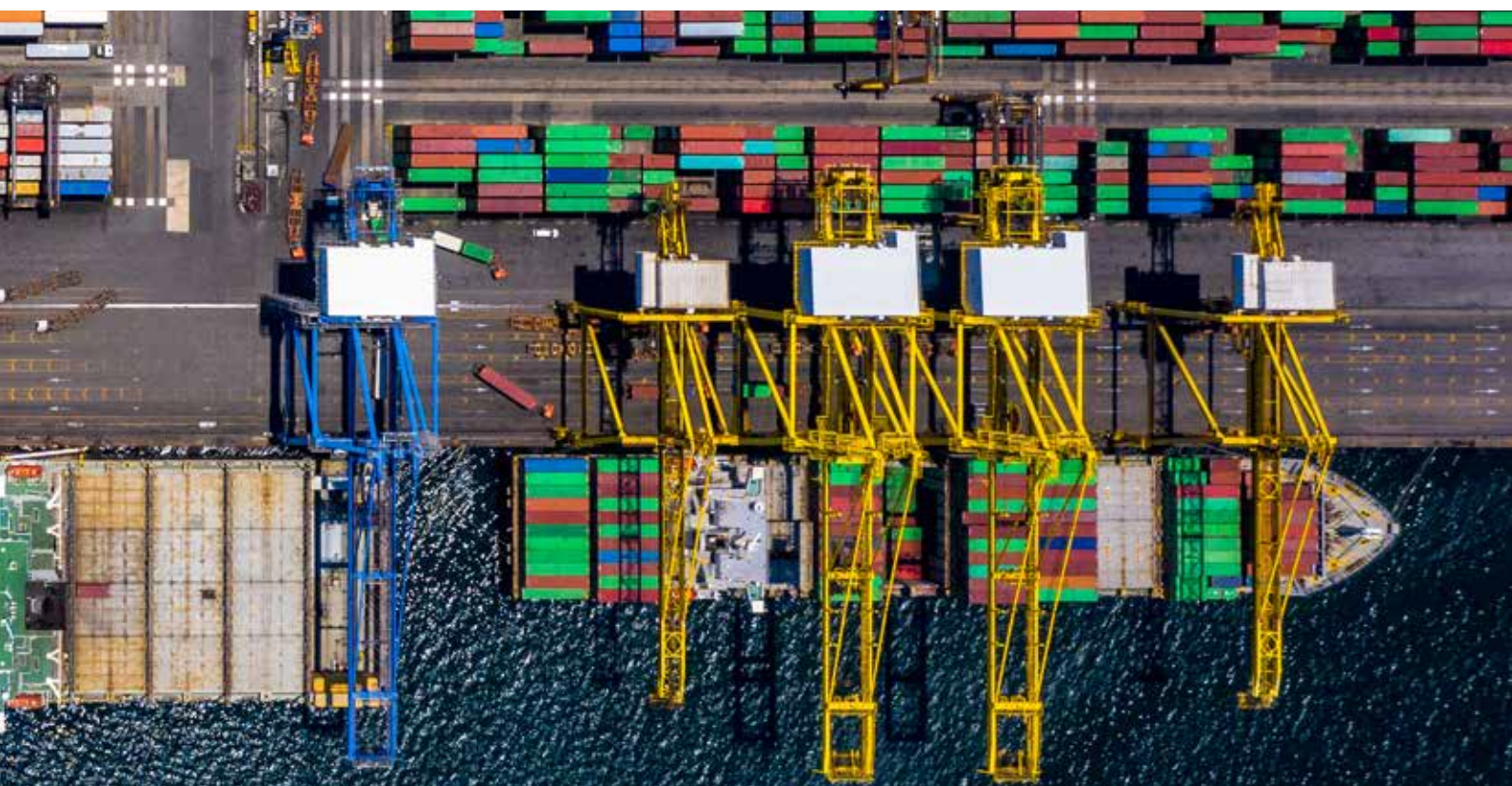



## Chapter 3

# Critical policy and industry actions in the 2020s

In some sectors of the economy, accelerated decarbonisation can be driven via the use of a small number of well understood and powerful policy levers:<sup>156</sup>

- In the power sector, dramatic falls in the cost of renewables were achieved because supply-side focused policy levers, which provided price certainty and initial subsidy (originally via feed-in tariffs and subsequently using contract auctions), attracted investment and unlocked powerful economies of scale and learning curve effects. The parallel ETC clean electrification report describes the mix of policies required to maintain rapid progress in power decarbonisation and renewable generation scale-up: in general, these are broad policy mechanisms, which do not entail policies focused on specific end applications, nor developments focused on specific regions.<sup>157</sup>
- Similarly, in the light duty road transport sector, initial government support for battery R&D, together with subsidies for initial EV purchase, have driven such a dramatic fall in battery costs and improvements in performance, that massive private investment will now itself drive very rapid further progress. Government announcements on dates beyond which no new ICE vehicles can be sold are now reinforcing this private-sector driven advance.

Specific features of the hydrogen economy mean that the policy levers required are inevitably more varied and, in some cases, need to be focused on specific sectors, regions or technologies. This is because:

- Driving down clean hydrogen costs – in particular green hydrogen costs – requires reaching a certain volume of production (ca. 50 GW). However, demand for such a volume of clean hydrogen does not currently exist, as clean hydrogen is higher cost than existing grey production and comes at a cost premium vs. competing technologies in almost all cases (see Section 1.2). As a result, to a greater extent than direct electrification, hydrogen faces a ‘chicken-and-egg’ problem, which requires the simultaneous stimulus of hydrogen supply and demand.
- Moreover, while many applications of direct electrification – including of road transport – do not impose a “green cost premium” (indeed in many cases they deliver a cost advantage), many hydrogen applications will entail additional costs, even if cheap clean hydrogen is available, requiring public policy instruments to incentivise the switch from fossil fuels to hydrogen and establish a level playing field among competitors.
- While electricity is already ubiquitously available over existing transmission and distribution networks which, at least in developed countries, reach every household and business, some hydrogen applications will depend on the development of new hydrogen transport infrastructure (or the retrofit of gas pipelines).
- The green versus blue choice introduces an additional complexity for public policy, which must address potential scale-up bottlenecks for both routes and determine an appropriate approach dependent on local circumstances and starting points.
- Early and cost-effective development of the hydrogen economy may best occur within clusters which de-risk investment and support the simultaneous and self-reinforcing development of hydrogen production and end use.

As a result, public and private action to drive hydrogen application must combine broad policy levers with focused interventions, which sometimes require coordination between multiple actors. Key priorities should include:

- Overall quantitative supply and demand targets to provide a clear horizon for private sector action;
- Carbon pricing to create broad incentives for decarbonisation of hydrogen supply and of potential use cases;
- Tailored demand-side policies to support demand growth and compensate the “green premium” on a sector-by-sector basis;
- Targets for the development of large-scale electrolysis manufacturing and installation and public investment support for the first large-scale electrolysis manufacturing and installation projects;
- Public support and collaborative private-sector action to bring to market key technologies and capabilities across production, transportation and storage, and use, which may not develop fast enough via private-sector action alone;
- The development of clean hydrogen industrial clusters, through coordinate private-sector action, supported by national and local government;

<sup>156</sup> ETC (2020), *Making Mission Possible*

<sup>157</sup> ETC (2021), *Making Clean Electrification Possible: 30 years to electrify the global economy*

- International rules and standards on safety, purity and clean hydrogen certification.

Combined, these policies, together with those set out in the parallel ETC clean electrification report<sup>158</sup>, can unleash the investments required to build the hydrogen value chain (as described in Section 2.7).

## I. Critical targets for 2025 and 2030

Given the tiny size of clean hydrogen deployment today (<1% of dedicated production), a rapid acceleration is critical in the 2020s to enable the ramp-up of the hydrogen economy discussed in Chapter 2. In this context, targets for the overall development of production, transport and demand can help unleash a self-reinforcing cycle of private investment for each step of the value chain by providing greater certainty to investors.

These targets need to be set at national (or EU) level, but it is possible to illustrate the orders of magnitude required at a global level. A significantly accelerated ramp-up of clean hydrogen supply and use is required over the next decade – globally, by 2030:

- The production of clean hydrogen should reach 50 Mt by 2030, unlocking average clean hydrogen production costs of well below \$2/kg in all regions and putting capacity scale-up on a trajectory to reach 2050 targets.
- The majority (60%+) of the corresponding demand should stem from decarbonisation of existing hydrogen uses, combined with early scale-up of key new uses of hydrogen in mobility (i.e. for shipping, long-distance trucking, aviation) and industry (e.g., steel).

Exhibit 3.1 illustrates the relative orders of magnitude required at a global level in 2025 and 2030 across the key elements of the value chain (production, transportation and storage, demand).

### Accelerating clean hydrogen production and use in the 2020s By 2025 and 2030 we must...

	2025	2030
Production / Supply	<ul style="list-style-type: none"> <li>• Reach 15+ GW cumulative electrolyser capacity installed, equivalent to ca. 10 large green hydrogen clusters – on route to 50GW by 2027 – to rapidly approach cost-tipping point</li> <li>• Retrofit 30 existing hydrogen plants and have 150+ blue projects in early development stage to accelerate ramp-up of blue hydrogen production</li> <li>• Stop building new grey hydrogen facilities</li> </ul>	<ul style="list-style-type: none"> <li>• Reach well below \$2/kg for green hydrogen production in all regions, based on ca. 200 GW cumulative installed electrolyser capacity</li> <li>• Build more than 40 large-scale electrolyser production factories (2 GW each)</li> <li>• Have 50%+ of grey hydrogen plants converted to blue</li> </ul>
H <sub>2</sub> Transport & Storage	<ul style="list-style-type: none"> <li>• Install short-distance hydrogen distribution pipelines in at least 40 early-mover clusters</li> <li>• Have at least 10 salt caverns in operation for geological hydrogen storage to support green hydrogen clusters</li> </ul>	<ul style="list-style-type: none"> <li>• Reach 100+ geological hydrogen storage caverns (with both salt and rock caverns)</li> <li>• Begin connection of industrial clusters via transmission lines to enable access to favourable VRE and geological storage sites outside clusters</li> </ul>
Use / Demand	<ul style="list-style-type: none"> <li>• Start switching demand from existing uses (refining and ammonia) to clean hydrogen</li> <li>• Develop a pipeline of 50+ consortia with “go-live dates” pre-2030 for clean hydrogen off-take (with off-takers from shipping, aviation, steel, heavy duty road)</li> <li>• Improve TRL of least ready use-cases of hydrogen (e.g., commercial-scale pilots for steel, synfuels)</li> </ul>	<ul style="list-style-type: none"> <li>• Reach ca. 50 Mt p.a. of total clean hydrogen demand with majority (60%+) from decarbonising existing hydrogen uses and rest from emerging new use-cases</li> <li>• Have 15+ commercial-scale hydrogen-DRI steel plants in operation</li> <li>• Start using hydrogen-based power generation for week-by-week system balancing</li> </ul>

Exhibit 3.1

SOURCE: SYSTEMIQ analysis for the Energy Transitions Commission (2021)

158 ETC (2021), *Making Clean Electrification Possible: 30 years to electrify the global economy*

## II. Carbon pricing – an essential and powerful lever

Carbon pricing should ideally play a major role in creating incentives to develop alternatives to fossil fuel use in each of the major potential end-uses of hydrogen. It has the advantage of being technology-neutral – providing a strong incentive for decarbonisation, while leaving it to the market to determine the least-cost portfolio of solutions – and driving decarbonisation across all sectors of the economy. It would be a powerful lever both to accelerate the conversion of existing grey hydrogen production to clean hydrogen production routes, and to reduce/overcome the green cost premium in end-use applications. Ideally, similar carbon prices should be applied across the world to avoid competitive distortions in sectors which are exposed to international trade. If this is not possible, instruments such as border carbon adjustments may be required to deal with competitiveness challenges in some sectors (e.g., steel).<sup>159</sup>

The carbon prices likely needed to make hydrogen use cost-effective versus conventional fossil fuels vary significantly by sector – potentially as low as \$60/tonne of CO<sub>2</sub> for steel, but possibly over \$150/tonne in long-distance shipping and aviation even in the long term (as discussed in Section 1.2 and Exhibit 1.17). Prices within the EU ETS are now forecast to reach about €80/tonne (ca. \$95/tonne) by 2030.<sup>160</sup> If the ETS was extended to cover the steel sector (i.e., with free allocations phased out, alongside the introduction of a border carbon adjustments<sup>161</sup>), that would be sufficient to drive significant investment in the 2020s.

Achieving significant carbon prices on a global level, which apply across the harder-to-abate sectors – with a target of around \$100 per tonne by 2030 with expected increases in subsequent decades – should therefore be a key public policy priority. Regardless of progress made on carbon pricing itself, all remaining fossil fuel subsidies – both at production and at consumption level – should also be removed as soon as possible to limit distortion of competition between high-carbon and low-carbon energy sources and accelerate decarbonisation efforts.

## III. Demand-side support – compensating the green premium sector by sector

While carbon prices should play a major role, they will often be insufficient to unlock investment in several key sectors in the next 5-10 years. They should therefore be complemented, at least initially, by other measures which drive early hydrogen demand:

- **Mandates** which require a rising percentage of fuels to come from zero-carbon sources, including potentially hydrogen and hydrogen derivatives. Amongst the strongest policy signals available, mandates could be particularly powerful instruments in long-distance shipping, aviation, and current hydrogen uses.<sup>162</sup> Requirements for a rising percentage of fuel to come from non-fossil fuel sources can help overcome the 'chicken-and-egg' barrier to achieving economies of scale to reduce costs.<sup>163</sup> The Mission Possible Partnership (MPP) initiatives in shipping (the Getting to Zero Coalition) and aviation (Clean Skies for Tomorrow) are currently assessing options for such an approach. For example, the Clean Skies for Tomorrow coalition is calling for the introduction of blending mandates for sustainable aviation fuels within the European Economic Area to be implemented by 2025 at the latest, with a blending level increasing over time in line with a net-zero trajectory for the sector.<sup>164</sup> In addition, mandates could eventually be extended to outright bans, for example, a ban on new greenfield grey hydrogen production sites from 2025.<sup>165</sup> Banning any existing grey hydrogen

<sup>159</sup> Border carbon adjustments would effectively require imported goods to pay carbon taxes according to the local jurisdiction. See further details in Section 2.5 "Competitiveness challenges in international traded sectors" and Chapter 4 Key Priority 5 "Remove fossil fuel subsidies and tax carbon (and other GHGs) to create appropriate price signals" in ETC (2020), *Making Mission Possible*.

<sup>160</sup> BloombergNEF (2021), *1H2021 Hydrogen Market Outlook*

<sup>161</sup> In Europe, free allocations of credits is used for sectors considered at high risk of carbon leakage (e.g., steel).

<sup>162</sup> Mandates work particularly well where decarbonisation is likely to occur primarily through the use of a "drop-in fuel" in existing engines (e.g., aviation) or retrofitted engines (e.g., shipping), with minimal additional retrofitting required outside this. The form and focus of mandates will also differ, e.g., percentage of clean fuel per year for shipping, percentage of SAF drop-in fuel for aviation, and percentage of clean hydrogen or emission intensity for existing uses of hydrogen.

<sup>163</sup> Existing blending mandates and fuel regulations for internal combustion engines can be used as inspiration, but failed to incorporate stringent sustainability measures.

<sup>164</sup> With sub targets for synfuels, but not yet a clear policy for hydrogen aircrafts. Source: Clean Skies for Tomorrow (2020), *Joint Policy Proposal to Accelerate the Deployment of Sustainable Aviation Fuels in Europe*.

<sup>165</sup> Recent large scale grey hydrogen deployments show that mandates may be required to accelerate the switch from grey hydrogen to clean hydrogen. Source: AirProducts, "Air Products to Make Largest-Ever U.S. Investment of \$500 Million to Build, Own and Operate Its Largest-Ever Hydrogen SMR, a Nitrogen ASU and Utilities Facilities, and Wins Long-Term Contract to Supply Gulf Coast Ammonia's New World-Scale Texas Production Plant", 8<sup>th</sup> January 2020.

production, for example beyond 2035 if not before, would also help to accelerate retrofitting of existing assets.<sup>166</sup> Grid carbon intensity standards, another form of mandate, can also be used to accelerate the development of zero-carbon energy technologies, especially zero-carbon dispatchable generation to meet seasonal balancing challenges such as hydrogen burnt in compatible CCGTs (see ETC clean electrification report<sup>167</sup>).

- **Product carbon standards** in which CO<sub>2</sub> standards are defined for products (e.g., cars), at either intermediary, semi-finished or finished levels, based on consistent and verifiable lifecycle carbon emissions assessment methodologies. Functioning in a similar way to mandates, such standards would aim to prevent products below the defined threshold from being traded in a jurisdiction and send a strong, direct signal to producers to meet a particular carbon intensity target. This solution can more easily be applied to products with existing energy efficiency standards that can be expanded to encompass lifecycle carbon footprint, like construction or white goods. It requires traceability of emissions along sometimes long value chains.
- **Voluntary green product commitments**, with companies which sell products to end consumers (e.g., auto manufacturers, airlines, or white good manufacturers) purchasing green input products or services produced with zero-carbon hydrogen (e.g., steel made via hydrogen-DRI, synthetic aviation fuels, or ammonia shipping services<sup>168</sup>). Such commitments are most likely to be feasible where there are only a small number of players in the total value chain which can collectively rapidly add up to significant volumes of demand. They are more difficult where a long chain of different parties makes it more challenging to trace the “clean” product and to achieve cross value chain agreement. Many harder-to-abate sector initiatives, including within both steel and aviation, are currently assessing the opportunities for this approach.<sup>169</sup>
- **Green public procurement policies**, through which governments mandate or preferentially purchase products based on carbon-related criteria. The biggest opportunity is likely to be in steel and concrete, as public building and infrastructure projects represent a meaningful share of demand for those sectors (although they utilise predominantly scrap-based steel rather than primary steel).<sup>170</sup>

Beyond mechanisms that aim to create a market for low/zero-carbon products and services at a premium price, targeted policies can also contribute to bridging the cost premium associated with clean hydrogen-based products and services. **“Contracts for difference”** would pay a producer of a green product a subsidy that would totally or partially compensate the difference between the “green” price and the market price of the high-carbon alternative, with reverse auctions used to minimise the subsidy required.<sup>171</sup> This approach could be applied to the production of green or blue hydrogen itself, with the difference paid relative to the grey hydrogen price. This could unlock clean hydrogen use in existing applications, but would likely be insufficient to bridge the remaining “green premium” in many other end uses. The same approach can also be designed to be sector- or product-specific, and could work well, for instance, in the ammonia industry, with a limited number of companies and large offtake volumes in a market with defined spot prices. Germany’s national hydrogen strategy also aims to test the use of carbon contracts for difference in the steel sector before potentially applying it to other sectors.<sup>172</sup>

The balance and specific implementation details of these mechanisms will change according to the local policy environment, over time and by sector (Box G). Supportive policy frameworks that provide long-term certainty on demand and which bridge the cost premium associated with clean hydrogen-based products and services are crucial to improving investor confidence and accelerating the pace of investment. They should be announced ahead of their implementation date to enable early investment in anticipation of future demand (e.g., progressively rising fuel blending mandate by 2025 announced in the early 2020s to account for the lead time for the conception and construction of sustainable fuel plants). National Hydrogen Strategies setting out a strategic vision of future clean hydrogen demand outlook and clarity on supporting policies that will underpin demand growth can provide forward-looking certainty to investors and unlock large-scale investment (Section 3.8 and Box H).

166 As an example, the Spanish hydrogen strategy foresees that in 2030, 25% of current industrial hydrogen uses need to stem from clean hydrogen.

167 ETC (2021), *Making Clean Electrification Possible: 30 years to electrify the global economy*

168 For example, commitments from major logistics firms to shift to low-carbon trucking, shipping and aviation to reduce their scope 3 emissions.

169 These include (not exhaustive): Mission Possible Partnership, SteelZero, CementZero, Clean Cargo Group.

170 Cement is another sector with a significant role for public procurement, but the use of clean hydrogen cannot abate the CO<sub>2</sub> emissions produced during the formation of cement (only the emissions from high temperature heat provision).

171 A more specific form for hydrogen use in the power system (Dispatchable Power Agreements (DPAs)) are being developed in the UK and could enable hydrogen power generation (as well as natural gas + CCS) to operate flexibly to complement variable renewables.

172 Carbon contracts for difference are calculated based on the effective carbon price a clean production route would offer compared to the current carbon market price.

Source: BMWI Germany (2020), *The national hydrogen strategy*.

# Demand side support: Most effective option to cover the cost premium will vary by sector

		Long-term, cross-sectoral policy	Key instruments in the 2020s			
		Carbon Pricing	Mandates or product standards	Voluntary green premium	Public procurement	Contracts for difference
Actor	Policy makers		Industry / Consumer		Policy makers	
Mechanism	Decrease fossil competitiveness		Create demand for green products			Cover cost differential
Main cost bearer	Diluted through all end-users		Green product end-user		Government budget	
Existing uses	Fertiliser	Carbon tax likely to have impact at moderate CO <sub>2</sub> price	Lifecycle-emissions standards for fertiliser production	Premium sector occupied by organic farming	Little government procurement activity	Contract for difference vs. ammonia spot price
	Refining	CO <sub>2</sub> emissions from entire refinery covered, H <sub>2</sub> not sole target	Progressively tighten emissions intensity targets for refineries, H <sub>2</sub> not sole target	Difficult as end-products not decarbonised	Little government procurement activity	Difficult to envision as end-products not decarbonised
Large long-term uses with significant lead times	Steel	Feasible but high risk of carbon leakage, will require border carbon adjustments	Lifecycle/Embodied carbon emissions standards for automotive & construction	Attractive for short, consolidated value chains (e.g. cars - ca. 12% current steel production)	Leverage national infrastructure projects; however, large share of scrap-based steel	Carbon contract for difference for primary (ore-based) steel production
	Aviation	Difficult to implement for international traffic	Progressively rising blending mandates in key regions (e.g. EEA)	Ticket surcharge for "green flight"	Little government procurement activity	Contract for difference for SAF vs. kerosene, or for low-TRL SAF vs. high-TRL SAF
	Shipping	Difficult to implement for international traffic	Mandate on share of green shipping in total traffic applied at port levels initially; IMO regulation ideal	Development of a "green shipping" offer with cost pass through to end consumer	Little government procurement activity	Contract for difference for sustainable fuels vs. fuel oil
	Power	Impose taxes or emissions trading schemes to make unabated fossil less competitive	Grid carbon intensity standards and / or bans on particular fossil technologies	End-consumer may pay premium for low-carbon providers, but limited impact on H <sub>2</sub>	Power purchase for public buildings, but focus on renewables & limited impact on H <sub>2</sub>	Dispatchable power agreements or auctions to encourage H <sub>2</sub> peaking plants
Possible future uses where relative advantages vs. other decarbonisation options no yet clear	Long-distance buses & trucking	Via diesel taxation	Progressively tightened emissions standards, or ICE bans	Development of a "green logistics" offer with cost pass through to end consumer	Leverage procurement of buses for long distance travel, but limited volumes	Small consumption volumes makes CfD impractical
	Rail	Via diesel taxation	Small market makes mandate less likely	Ticket surcharge for decarbonised travel	Little government procurement activity	Small consumption volumes makes CfD impractical
	Captive fleet	Via diesel taxation	Small market makes mandate less likely	Green premium small and diluted within value chain	Little government procurement activity	Small consumption volumes makes CfD impractical
	Building heating (see Box B)	Via natural gas taxation	Progressively rising building efficiency standards Blending mandates	End-consumer may pay extra for decarbonised heating	Heating purchase for public buildings, but limited volumes	Contract for difference vs. natural gas

Box G

## IV. Supply-side support – national targets and investment support for electrolyser capacity growth

Public policy is often best designed on a technology-neutral basis. But where there is a known technology which is central to the decarbonisation of multiple sectors of the economy and could achieve rapid cost reduction thanks to scale effects (as for instance was the case with solar PV), there is an appropriate role for policies which accelerate economy of scale and learning curve effects in that specific technology.

It is sufficiently clear that dramatic electrolyser cost reductions are possible, and that green hydrogen will play a major role in a zero-carbon economy for policymakers to seek to spur that cost reduction cycle by setting growth targets for installed capacity. By contrast, as described in Section 1.2, opportunities for blue hydrogen cost reduction will be more incremental and less dependent on total scale of all blue hydrogen developments.

Targets for electrolyser capacity to be achieved by given future dates – such as the EU's commitment to 40 GW by 2030 (Exhibit 2.1) – should therefore be a key part of the policy toolkit to support the take-off of the hydrogen economy. These targets must, however, be underpinned by credible commitments to introduce policies which will ensure those targets are achieved, including crucially, policies which will ensure coordinated growth in demand for clean hydrogen produced (as described above in Section 3.3). In the first few years of the scale-up, investment in electrolyser manufacturing capacity and in hydrogen production assets could also benefit from public investment support in the form of de-risking mechanisms that will crowd-in private capital in the face of still uncertain market trends.

Green hydrogen growth must also go hand-in-hand with a significant build-out of variable renewable energy generation, and thus support for green hydrogen should be tightly linked with mechanisms to support the addition of renewables capacity. This includes effective power market design, which enables green hydrogen projects to benefit from low renewable electricity prices in periods of overproduction and sell demand-side response services to the grid to help balance power systems. Similarly, accelerated permitting processes for net-zero power generation will enable faster project uptake for green hydrogen (see parallel ETC clean electrification report for further details).<sup>173</sup>

In addition, public policies can encourage the investment required by establishing taxonomies of lower carbon technologies and applications which help guide portfolio decarbonisation by both asset managers and banks.

## V. R&D and deployment support for new technologies

Provided credible quantitative targets are in place, alongside commitments to use carbon pricing and other support policies to drive early demand growth, many key elements of technology development will be driven by private-sector investment alone. Electrolyser efficiency improvements and cost reductions<sup>174</sup> will be pursued aggressively by private companies seeking to grasp the huge commercial opportunity of green hydrogen scale-up (just as rapid improvements in battery technology are now being driven by private companies). Key innovation areas likely to be driven by the market include:

- Electrolyser technology improvements (e.g., faster ramping of alkaline electrolyser, less scarce catalysts for PEM electrolysers, efficient utilisation of waste heat to increase efficiency);
- Blue hydrogen production process innovation (e.g., improved capture rates at lower cost,<sup>175</sup> further development of methane pyrolysis technology);
- High efficiency hydrogen-ready gas turbines for peaking generation in the power sector.

<sup>173</sup> ETC (2021), *Making Clean Electrification Possible: 30 years to electrify the global economy*

<sup>174</sup> These include the commercialisation of SOEC electrolysis and reversible electrolysers/fuel cells as well as improvements in operational excellence and automated manufacturing, reduction of balance of plant costs (e.g., standardisation of power electronics, electrochemical hydrogen compression) and stack improvements (e.g., reducing diaphragm thickness and catalyst loading).

<sup>175</sup> Examples include, improvements of today's adsorbent technology (e.g., lower heat requirement for CO<sub>2</sub> release after capture), and reductions in CCS plant footprints to reduce initial investments required and simplify integration into existing refinery/chemical complexes.





There are however some key technologies with lower levels of technology readiness today, where more direct government support in the form of R&D, pilot and commercial-scale demonstration funding would be appropriate. These include:

- **Supply-side technologies:** Electrolyser recycling and materials circularity can lower the demand for new primary resources, thus contributing to lower geopolitical resource tensions and decrease the overall environmental footprint of clean hydrogen production. Further improvements to integrate electrolysers with variable renewable energy generation (e.g., offshore wind electrolysis<sup>176</sup>) can help to lower costs, decrease electricity curtailment and improve electrolyser utilisation.
- **Storage technologies:** Rock caverns and depleted gas fields for hydrogen storage are still at an earlier stage of technology readiness and it remains unclear if their porosity may limit the useability for hydrogen storage. Compressed hydrogen storage in steel tanks remains very expensive; thus, lower-cost materials as well as higher storage pressures may enable lower storage costs in regions without geological hydrogen storage.
- **Transport technologies:** Further developments in shipping liquid hydrogen and ammonia may help to lower long-distance transport costs (e.g., using the transport of low-temperature liquid hydrogen and ammonia to optimise refrigerated shipping). Further technological developments of natural gas pipeline retrofitting including for example coatings to improve longevity, high-pressure resistance and lower hydrogen leakage of soft steel pipelines which may de-risk investments and lower transport costs.
- **Technologies for the use of clean hydrogen:**
  - Hydrogen for power system balancing: Further development is needed for 100% ammonia gas turbines.
  - Hydrogen-DRI for steel: While many industrial actors are active in this field now (see Section 1.1), the TRL is still relatively low (5) and support to accelerate this development would be appropriate.<sup>177</sup>
  - Ammonia-based shipping: An acceleration of commercial-scale pilots is essential to grow hydrogen demand from shipping in the 2020s and enable decarbonisation of the long-distance shipping sector in the 2030s and 2040s.<sup>178</sup>
  - Direct air capture (DAC) of CO<sub>2</sub>: DAC will enable hydrogen applications that require a sustainable carbon source such as synthetic fuels for aviation, plastics production and potentially methanol for shipping.<sup>179</sup>
  - Industrial heat applications of hydrogen: Achieving temperatures over 1000°C with hydrogen remains technologically challenging, and the long-term balance between direct electrification and hydrogen for high temperature heat production is currently unclear. Direct public support for early-stage development and pilot projects for both direct electrification and hydrogen would therefore be useful.
  - Using hydrogen in chemicals production: There is a wide range of potential routes to decarbonisation of the chemicals industry, which is a highly diversified sector in itself. Given low TRL and lack of clarity on the technology pathways, public support for early-stage development and experimentation would be justified.
  - Short-distance hydrogen planes and ships: These vehicles could offer a cost-competitive decarbonisation route, but the TRL is still low (3-4 for planes, 4-7 for ships<sup>180</sup>) and require further technology development and piloting.

Alongside innovation support, governments should also develop a strategic vision for key infrastructure requirements, by (see also Exhibit 3.5):

- Identifying potential hydrogen and CO<sub>2</sub> storage sites
- Identifying the potential need for national or international hydrogen networks including through the retrofitting of existing infrastructure where possible.

<sup>176</sup> Source: BloombergNEF (2021), *Hydrogen from offshore wind*

<sup>177</sup> IEA (2020), *ETP Clean Energy Technology Guide*

<sup>178</sup> Energy Transitions Commission for the Getting to Zero Coalition (2020), *The first wave – A blueprint for commercial-scale zero-emission shipping pilots*

<sup>179</sup> Direct air capture is very likely to be required since the carbon resources from sustainable biomass are expected to be constrained and likely insufficient to meet all demands. CO<sub>2</sub> from DAC can result in negative emissions if combined with CCS. Source: ETC (Upcoming, 2021), *Making a Sustainable Bio-Economy Possible*.

<sup>180</sup> IEA (2020), *ETP Clean Energy Technology Guide*

## VI. Hydrogen clusters development

Each of the policy instruments described above would support the development of hydrogen production and use, whether or not early developments occurred in clusters. In addition, however, governments and companies should focus on specific opportunities to develop early hydrogen clusters – as outlined in Section 2.4 – by:

- Identifying potential locations for cluster development where multiple end-users can share production, transport and storage capacity – and therefore split associated costs and risks;
- Encouraging the development of consortia between multiple companies along the value chain in both hydrogen production and end use – using the national and/or local government legitimacy and reach to facilitate early discussions, and
- Jointly developing solutions to reduce the significant investment involved in early cluster development – which, in addition to facing potentially high near-term costs of clean hydrogen production, will often involve costly first-of-a-kind, pilot and demonstration facilities in various end uses –, including by mobilising different forms of government support to strengthen the business case for the private-sector participants (see below);
- Accelerating procedures for planning and permitting on local and national levels (e.g., accelerated permitting of CCS and variable renewable energy developments).

Key CAPEX and OPEX investment dimensions that consortia should aim to address for early clean hydrogen clusters (2020s) include the following:<sup>181</sup>

- In many green hydrogen clusters, the majority of total investment costs (ca. 80%) will lie in hydrogen production assets, of which ca. 70% is required to develop the zero-carbon electricity capacity needed to support production (Exhibit 3.2).<sup>182</sup>
- For blue hydrogen clusters, upfront investment needs will likely be lower (reflecting the larger operational costs related to natural gas feedstock)<sup>183</sup>, and are likely to be split between blue hydrogen production assets and hydrogen offtake equipment and assets (e.g., hydrogen-DRI facilities) (Exhibit 3.3).
- Pipeline or other local transport developments will often be relatively small (though crucially dependent on planning and permitting decisions). However, identification and development of appropriate storage facilities is crucial to keep costs low (as described in Section 2.5).<sup>184</sup>
- Investments in end-use sectors, although small compared with investments in green hydrogen production, will be significant for the industry players which must make them.

Therefore, in addition to appropriate short-term demand-side support to overcome the cost-premium on a sector-by-sector basis as described in Section 3.3, consortia should focus on opportunities to reduce those key costs and remove potential bottlenecks to development:

- For green hydrogen clusters, reducing the cost and risks involved in developing zero-carbon electricity supply for green hydrogen production, for instance via:
  - Reductions in / subsidies for grid connection costs and electricity tariffs,
  - Long-term corporate power purchase agreements between renewable power producers and clean hydrogen offtakers to provide future price certainty,
  - Long-term corporate hydrogen purchase agreements underwritten by government.

<sup>181</sup> Early green hydrogen clusters will face higher hydrogen production costs due to low installed capacities in particular in the early 2020s. In later years economies of scale and learning effects described in Section 2.1 will drive significant cost reductions.

<sup>182</sup> Investments are described from a perspective of consortia developing green hydrogen projects. The production of zero-carbon electricity assets is therefore considered a CAPEX investment (i.e., required to build dedicated renewable generation capacity to power the hydrogen production), rather than an OPEX cost (which would be the case if a hydrogen producer decided to purchase grid energy to power production).

<sup>183</sup> If electricity for a green hydrogen cluster was treated as OPEX, total operating costs for fuel (ie. natural gas for blue hydrogen and electricity for green hydrogen) would equal ca. 2x of total CAPEX investments (excl. finance) assuming favourable renewable energy generation costs and \$5/MMBtu natural gas cost.

<sup>184</sup> Steel tanks would likely increase the cost of hydrogen storage by a factor of ca. 50, increasing total investment by ca. 150%, and make the overall hydrogen cluster project costs prohibitively high.

# Renewables and electrolyser for hydrogen production ~80% of investment for a green hydrogen industrial cluster

Total investment cost for greenfield green hydrogen industrial cluster excl. financing costs (early 2020s)  
\$ million

Green H<sub>2</sub>

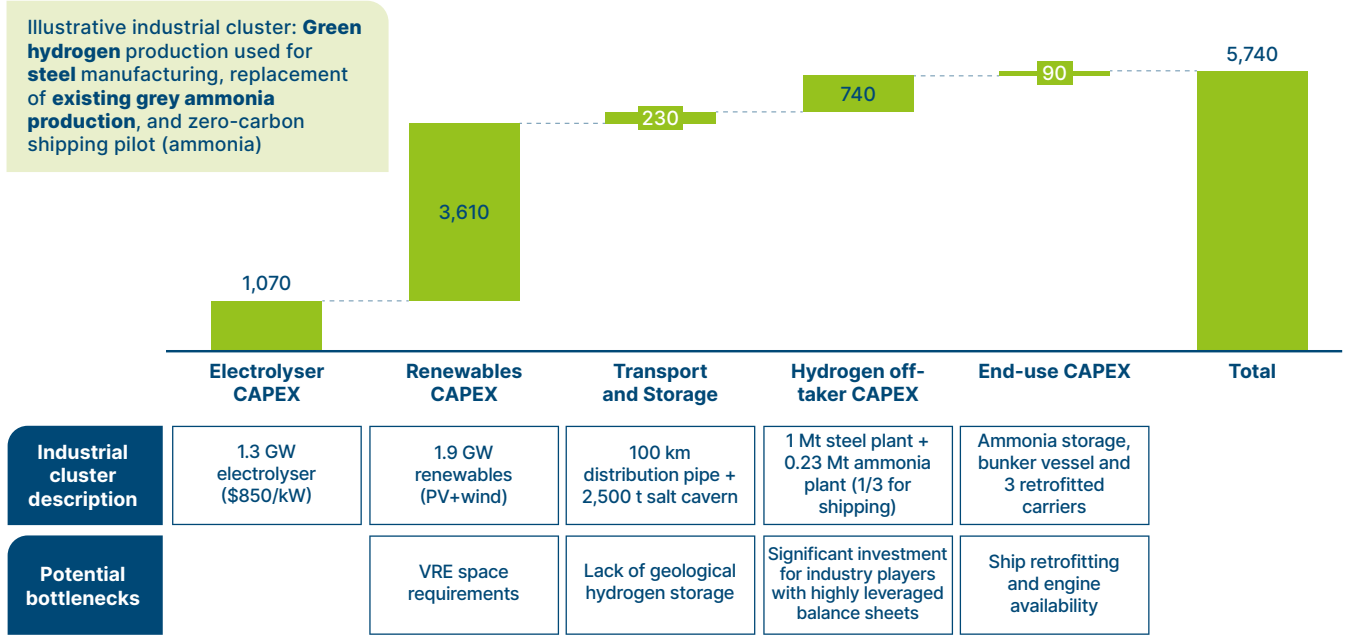

**NOTES:** Total investment would be \$2,130 million if renewables CAPEX were not considered. Power OPEX for corresponding levelized cost of electricity (\$27/MWh) would amount to ca. \$4.470 million corresponding to ca. 2x the total CAPEX investments.

**SOURCE:** SYSTEMIQ analysis for the Energy Transitions Commission (2021)

Exhibit 3.2

# Lower CAPEX investments in blue hydrogen industrial cluster are balanced by higher OPEX from natural gas feedstock

Total investment cost for greenfield blue hydrogen industrial cluster excl. financing costs (2020s)  
\$ million

Blue H<sub>2</sub>

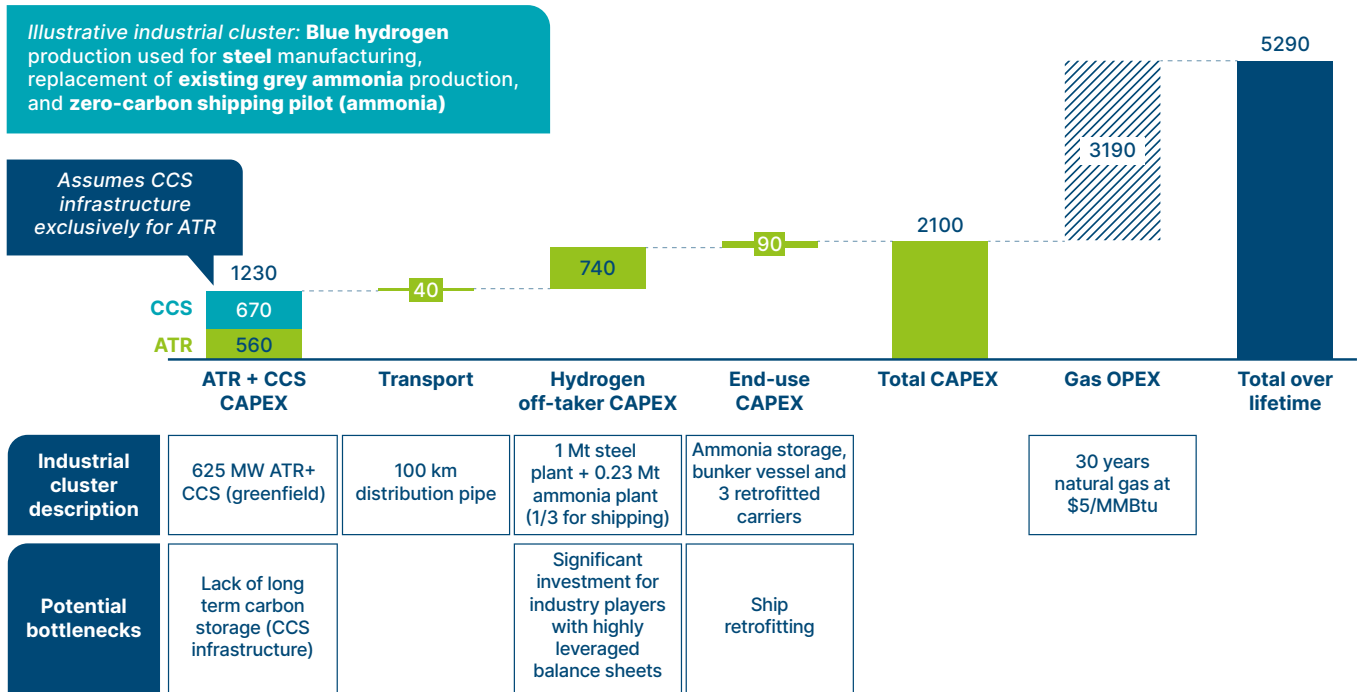

**SOURCES:** SYSTEMIQ analysis for the Energy Transitions Commission (2021)

Exhibit 3.3

- For blue hydrogen clusters, support CCS infrastructure investments, for example via accelerated infrastructure planning and permitting, as well as a regulated asset base (RAB) which provides a secure payback and return on investment.<sup>185</sup>
- Support hydrogen transportation and storage infrastructure development using similar mechanisms to CCS infrastructure support (e.g. accelerated permitting, reduce risks or use financial support mechanisms to access lower-cost capital).
- Investment support for early end-use applications: While investments in end-use assets and equipment are generally a small share of total costs when considered at the level of the cluster, they can be significant relative to the size and investment capacity of companies operating in those sectors. As a result, there may be a role for:
  - The use of public financial support mechanisms, combined with private investment in blended finance packages, to provide low-cost financing to support the early development of end-use applications;
  - Direct investment subsidy to decrease the upfront investment volume.

Pulling these different levers can significantly decrease the overall investment needs (and operating costs) for early clean hydrogen clusters.<sup>186</sup> For instance, ETC analysis for the Getting to Zero coalition found that targeted support for the first end-to-end zero-carbon shipping pilots using green hydrogen-based ammonia could reduce total investment needs from \$145 to \$48 million, and that this would reduce the “green premium” for zero-carbon shipping from 200% to 55%.<sup>187</sup>

## VII. Standards and Certifications

As outlined in Section 2.6, to facilitate the development of the hydrogen value chain on a global scale, international standards for clean hydrogen (and for derived products, in particular ammonia and synfuels) need to be established. These will provide greater clarity on product specificities to the increasing diversity of hydrogen off-takers. They should cover three key dimensions:

- Regulations enabling the safe handling of hydrogen and of ammonia, which both present safety risks – for instance, regulations on handling of ammonia at ports and its use as shipping fuel established by the International Maritime Organisation should be in place by 2025 at the latest;
- International standards on hydrogen purity levels, which will be essential to provide certainty to off-takers on the quality of the fuel they purchase – this matters in particular for fuel cell end-uses requiring high-purity hydrogen;
- Verifiable certification of lifecycle GHG emissions – covering CO<sub>2</sub> emissions in electricity provision and in blue hydrogen production, as well as methane leakages in the natural gas value chain for blue hydrogen production – underpinned by robust and consistent traceability and reporting mechanisms, which will ensure that the development of the hydrogen economy brings the expected climate benefits (and could justify cost premiums). These types of standards are beginning to emerge, for example in the EU:
  - The EU-funded CertifHy project represents a useful starting point defining standards for low-carbon hydrogen in terms of the maximum amount of CO<sub>2eq</sub> per kilogram of hydrogen on a full lifecycle basis. Initially the maximum has been set at 4.4 kg of CO<sub>2eq</sub> per kg of hydrogen which is about 60% below grey hydrogen levels, reflecting the capture rates easily achievable in SMR+CCS facilities (Section 1.2).

<sup>185</sup> RAB funding models are used in some countries to help de-risk large national infrastructure investments (in sectors such as power, gas, telecom or water). Private companies own, invest in and operate the infrastructure assets and the RAB model is used to provide a secure payback over extended period of time. Regulation is used to actively cap the prices and prevent mis-use of the infrastructure monopoly.

<sup>186</sup> Some of these support mechanisms have to be sustained for the lifetime of the asset, while direct capex investment support is a single “one-off” investment (and can take forms, like reimbursable advances or loan guarantees, which have a low medium-term impact on public budgets).

<sup>187</sup> Energy Transitions Commission for the Getting to Zero Coalition (2020), *The first wave – A blueprint for commercial-scale zero-emission shipping pilots*.

- The current EU taxonomy policy proposal suggests a stricter 2.26 kg of CO<sub>2eq</sub> per kg of hydrogen. This corresponds to achieving ca. 90% CO<sub>2eq</sub> capture during the blue hydrogen production process (1.1 kg CO<sub>2eq</sub> per kg of hydrogen) and 0.5 % upstream methane leakage.<sup>188</sup> For green hydrogen to meet this standard, the carbon-intensity of electricity used would have to be below 45 gCO<sub>2</sub>/kWh.<sup>189</sup> This is currently below most grid intensities in the world and illustrates the need for fast decarbonisation of the power system to produce large amounts of low-carbon green hydrogen.

Given the long lead times typically associated with building strong international alignment on these types of standards, corporates should collaborate to fast-track development of voluntary standards in the early 2020s to pave the way for discussions within coalitions of sector-relevant governments, ahead of agreement of global, government-backed certification schemes by 2030.

<sup>188</sup> It is important in this context to consider the short-term (20 years) global warming effect of methane rather than a commonly used, lower long-term effect (100 years).

<sup>189</sup> Very few countries have grid intensities below 45 g/kWh today. As an example, the EU average in 2019 was 275 g/kWh. This illustrates the need for rapid grid decarbonisation and dedicated renewables for green hydrogen production.



## VIII. Summary of critical actions for policymakers, industry, finance, innovators and consumers

Section 2.7 described the significant investments required to support hydrogen's major role in a zero-carbon economy. The policies described above, together with those set out in the parallel ETC clean electrification report<sup>190</sup>, will help unleash that investment.

The critical actions that policymakers, industry, finance, innovators and consumers need to take in the 2020s to put the hydrogen value chain on a feasible scale-up trajectory are summarised in the infographic concluding this section. These actions encompass simultaneous activities across the entire value chain: production, transport, storage and use.

At a national level, a key first step to support the development of the clean hydrogen economy should be to develop a National Hydrogen Strategy covering many of the elements discussed above, which can help provide greater certainty on future markets to private investors, overcome 'chicken-and-egg' issues of supply and demand growth, and accelerate clean hydrogen take-off. The key components of these national strategies are outlined in Box H.

### National hydrogen strategy – Best practices

<b>1</b>	<b>Long-term vision</b>	<ul style="list-style-type: none"> <li>● <b>Net-zero targets:</b> Implementation of hydrogen strategy as pillar of legally binding national net-zero target</li> <li>● <b>Import/Export:</b> Clear long-term vision on national energy supply &amp; security (electricity &amp; hydrogen import / export)</li> <li>● <b>Infrastructure:</b> National infrastructure vision (e.g. hydrogen pipelines, electricity grid developments, refuelling stations)</li> <li>● <b>Production technology:</b> Clarify expected roles of different clean hydrogen technologies within national context, i.e. given national resources, existing assets (production, transportation) and relevant off-take sectors</li> </ul>
<b>2</b>	<b>Concrete goals</b>	<ul style="list-style-type: none"> <li>● <b>Supply side aims:</b> <ul style="list-style-type: none"> <li>– <b>Clean hydrogen target:</b> Share of national hydrogen demand that must be clean in what timeframe</li> <li>– <b>Electrolyser capacity target:</b> Derived from clean hydrogen targets and national import / export plans</li> </ul> </li> <li>● <b>Demand side aims:</b> <ul style="list-style-type: none"> <li>– <b>Emission targets:</b> Per industry (e.g. steel, refining, fertiliser) quantitative targets, increasing over time</li> <li>– <b>Technology commitments:</b> Which / how hydrogen end-use sectors will be publicly supported considering local economy (e.g. focus on heavy industry, long distance transport and energy storage)</li> </ul> </li> </ul>
<b>3</b>	<b>Underpinning incentives</b>	<ul style="list-style-type: none"> <li>● <b>Carbon pricing:</b> Implement meaningful and increasing national carbon pricing mechanisms (international collaboration and alignment ideal)</li> <li>● <b>Deploy sector specific mechanisms</b> to create demand and to bridge the green cost premium in the next decade: <ul style="list-style-type: none"> <li>– <b>Mandates</b> (e.g., fuel mandates, bans of fossil technology), <b>product carbon standards</b> and public procurement standards to help accelerate demand growth</li> <li>– Address the cost premium via <b>sector specific contracts for difference</b></li> <li>– Foster creation of <b>voluntary green premium markets</b> through supporting traceability mechanism development</li> </ul> </li> <li>● <b>Investment support</b> of business cases for early industrial clusters including direct investment support and access to low cost capital for hydrogen production and end-use.</li> <li>● <b>Innovation support:</b> Identification of areas that require further development coupled with specific research funding (basic research through to applied – pilot, demonstration and commercial plant)</li> </ul>
<b>4</b>	<b>Infrastructure planning</b>	<ul style="list-style-type: none"> <li>● <b>Support of early projects for both green and blue hydrogen</b> via simplified permitting procedures for zero-carbon electricity deployment (one-stop shop) and CCS infrastructure development</li> <li>● <b>Power market design:</b> Role for grid-connected green hydrogen production in energy storage &amp; system balancing</li> </ul>
<b>5</b>	<b>Safety and regulation</b>	<ul style="list-style-type: none"> <li>● <b>Safety:</b> Commitment to international cooperation for hydrogen and ammonia handling</li> <li>● <b>Purity:</b> Set clear national standards on hydrogen purity for different end-uses</li> <li>● <b>Certification:</b> National clean hydrogen definition (kg CO<sub>2e</sub>/kg H<sub>2</sub>) alongside traceability mechanisms, in addition to international collaboration</li> </ul>
<b>6</b>	<b>Accountability</b>	<ul style="list-style-type: none"> <li>● <b>Advisory board:</b> Implement board of independent advisors (with representation of the entire value chain + local governance) to keep track of progress, propose key actions and ensure accountability</li> </ul>

Box H

SOURCE: SYSTEMIQ analysis for the Energy Transitions Commission (2021)

190 ETC (2021), *Making Clean Electrification Possible: 30 years to electrify the global economy*

# ACCELERATING CLEAN HYDROGEN IN THE 2020S

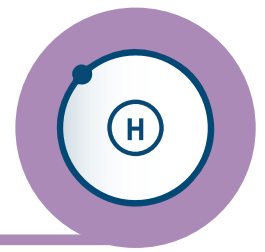

## 2030 TARGETS:

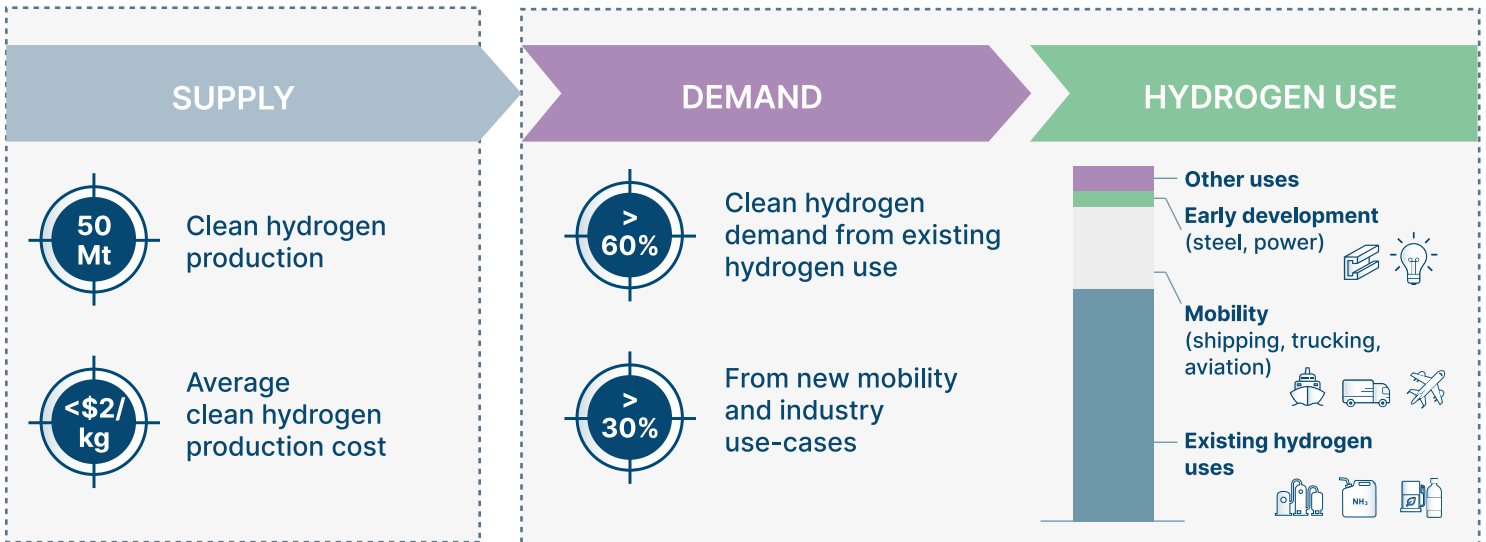

## TOP 5 ACTIONS ACROSS VALUE CHAIN

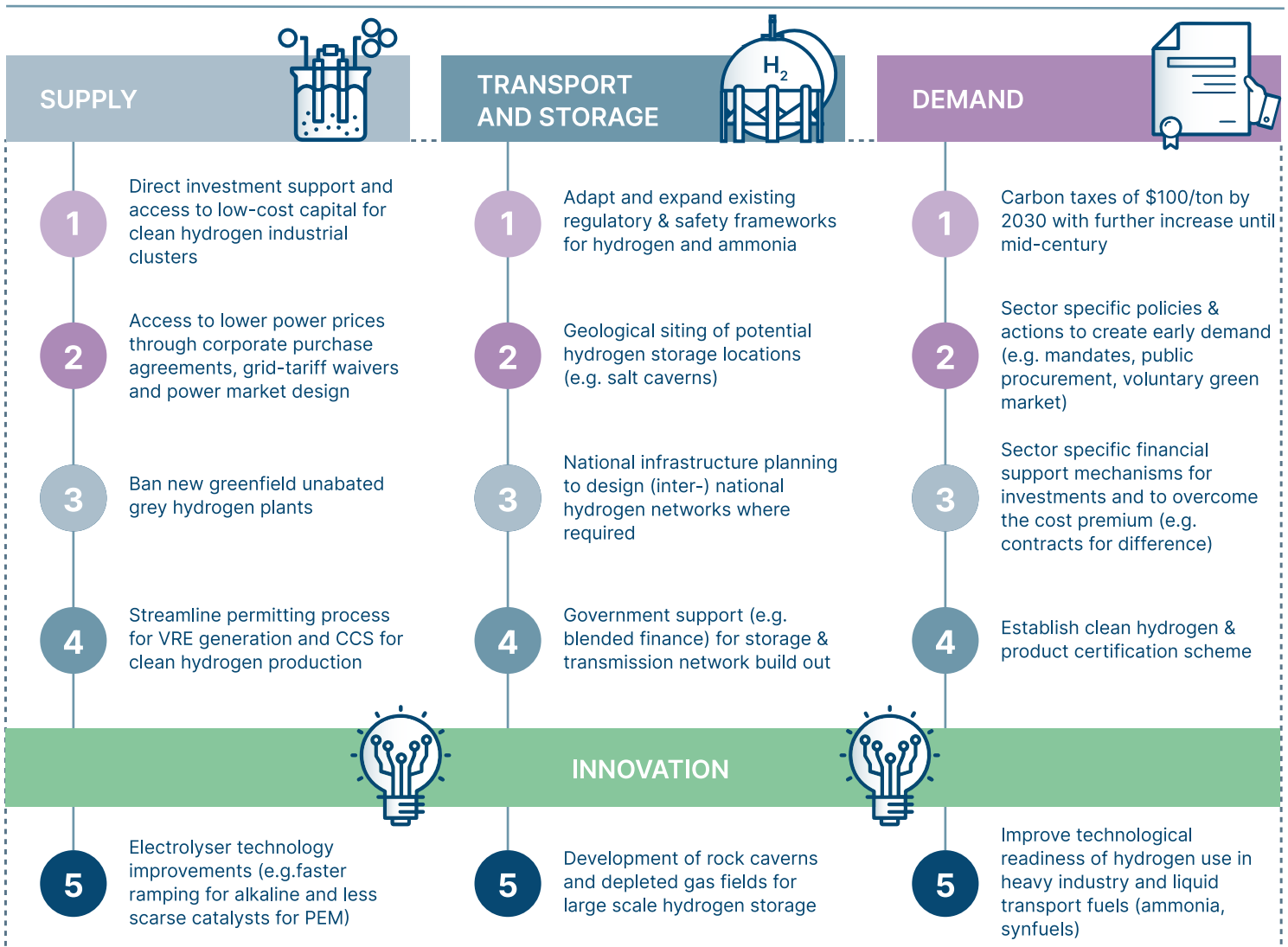



# — Concluding remarks

---

The Energy Transitions Commission believes it is possible to reach net-zero carbon emissions by mid-century, significantly increasing the chance of limiting global warming to 1.5°C. Actions taken in the coming decade are critical to put the global economy on the right track to achieve this objective. Succeeding in that historic endeavour would not only limit the harmful impact of climate change, but also drive prosperity and better living standards, while delivering important local environment benefits. Clean hydrogen can and must play a critical role, alongside massive clean electrification, in the profound transformation of the global energy system ahead – decarbonising those sectors that are difficult or impossible to electrify. Policymakers, investors, innovators, producers, buyers, and more generally both public and private sectors have a major responsibility to collaborate and act now at the local, national, regional and global scales to spur the development of the clean hydrogen economy in the 2020s – simultaneously driving early demand growth and supporting the scale-up of clean hydrogen supply to achieve the step-change outlined in this document before 2030.



# Acknowledgements

## **The team that developed this report comprised:**

Lord Adair Turner (Chair), Faustine Delasalle (Director), Ita Kettleborough (Deputy-Director), Andreas Wagner (Lead author), Alex Hall, Meera Atreya, Alasdair Graham, Tommaso Mazzanti, Mark Meldrum, Hettie Morrison, Aparajit Pandey, Francisco Pereira, Lloyd Pinnell, Elena Pravettoni, Caroline Randle, and Laetitia de Villepin (SYSTEMIQ).

## **This report builds on analyses developed by our knowledge partners, whom we would like to thank again for the quality of their inputs:**

Albert Cheung, Martin Tengler, Sanjeet Sanghera, Xiaoting Wang, Logan Goldie-Scot, Benjamin Kafri, Seb Henbest (BloombergNEF); Per Klevnäs, Anders Ahlen and Cornelia Jonsson (Material Economics); Arnout de Pee, Hamilton Boggs, Cynthia Shih, Eveline Speelman and Maaïke Witteveen (McKinsey & Company); Thomas Koch Blank, Ji Chen, Yiyan Cao, Stephen Doig, Elizabeth Hartman, Agnes Li, Bingqu Liu, Patrick Molloy, Tessa Weiss, Caroline Zhu (Rocky Mountain Institute); Shruti Dayal, Will Hall, G Renjith, A K Saxena, Thomas Spencer (The Energy and Resources Institute).

## **The team would also like to thank the ETC members and experts for their active participation:**

Rajit Nanda (ACWA Power); Christoph Beckmann, Elke Pfeiffer (Allianz); Javier Bonaplata, Nicola Davidson (ArcelorMittal); Abyd Karmali (Bank of America); Rod Davies, Doris Fuji, Nicholas Lawson, Ian Luciani, William Zimmern (BP); Jeanne Ng (CLP); Cameron Butler, Rob Kelly, Ro Maxwell, Wei Sue (Climateworks Australia); Dana Barsky (Credit Suisse); Bin Lyu (Development Research Center of the State Council); Rebecca Heaton (DRAX); Cristian Carraretto, Adil Hanif, Eric Rasmussen (EBRD); Dries Acke, Rebecca Collyer, Pete Harrison, Phillip Niessen (European Climate Foundation); Patrick Curran (Grantham Institute, London School of Economics); Matt Gorman (Heathrow Airport); Andrea Griffin (HSBC); Francisco Laveran, Samuel Perez (Iberdrola); Chris Dodwell (Impax Asset

Management); Ben Murphy, Andrew Symes (IP Group), Christopher Kaminker (Lombard Odier); Elizabeth Watson, James Smith-Dingler (Modern Energy); Matt Hinde, Terry McCormick, Joseph Northwood, Nick Saunders, Nicholas Young (National Grid); Peter Aagaard, Jakob Askou Bøss, Anders Holst Nymark (Ørsted); Aditi Garg (ReNew Power); Xavier Chalbot and Jonathan Grant (Rio Tinto); Charlotte Brookes, Roald Brouwer, Mallika Ishwaran, Nan Liu, Oleksiy Tatarenko (Royal Dutch Shell); Emmanuel Normant (Saint Gobain); Sandrine de Guio, Emmanuel Laguarrigue, Vincent Minier, Vincent Petit (Schneider Electric); Brian Dean (SE4All); Matteo Mazzoni, Claudio Montanari, Camilla Palladino, Xavier Lorenzo Rousseau (SNAM); Jesper Kansbod and Martin Pei (SSAB); Alistair McGirr (SSE) Jan Braten, Kristian Marstrand Pladsen (Statnett); Brian Dean (Sustainable Energy For All); Abhishek Goyal (Tata Group); Madhulika Sharma (Tata Steel); Reid Detchon (United Nations Foundation); Mikael Nordlander (Vattenfall); Johan Engebratt, Niklas Gustafsson, Staffan Lundgren, Alemar Reine, Staffan Rödjedal (Volvo Group); Rasmus Valanko (We Mean Business); Asger Garnak, Karl Hausker, Jennifer Layke, Tim Searchinger (World Resources Institute), Paul Ebert, Phil O'Neill, Geeta Thakoral, Frank Wouters (Worley

## **The team would also like to thank the ETC's broader network of experts for their input:**

Gniewomir Flies (Agora Energiewende); Kieran Coleman, Karl Zammit-Maempel (Climate Champions); Jenny Hayward (CSIRO); Ivan Pozgaj, Ivana Jemelkova, Anais Laporte, Daryl Wilson (Hydrogen Council); Peter Levi (IEA); Herib Blanco, Dolf Gielen (IRENA); Sam French (Johnson Matthey); Clemens Kienzler, Agata Mucha (McKinsey); Jon Andre Locke (Nel); Kash Burchett, Ben Dixon, Rafal Malinowski, Sanna O'Connor-Morberg, Eveline Speelman (SYSTEMIQ); Thomas Brown (Technische Universität Berlin); Tristan Kretschmer (Thyssenkrupp); Taylor Uekert (University of Cambridge); Johannes Hampf (Universität Giessen); Noam Boussidan (World Economic Forum); Sammy Van den Broeck, Jacobus de Letter, Rob Stevens (Yara)



The Making Mission Possible Series

# Making the Hydrogen Economy Possible:

**Accelerating Clean Hydrogen in an Electrified Economy**

April 2021

Version 1.0



Energy  
Transitions  
Commission